



ATTACHMENTS

The power of unrivalled versatility.

GSEE, 3509 RT 22 East, Somerville, NJ 08876
1-800-479-3857



Building with confidence.

Attachments make a single machine into many!

The vast range of unique Merlo attachments gives rise to a new meaning of versatility for telescopic handlers. For all models of Panoramic, Roto, Turbofarmer or Multifarmer there are countless innovative working tools which maximise their potential, enhance versatility, and optimise their use in any application sector, from construction to agriculture, waste recycling to industry.

Merlo telescopic handlers, fitted with these attachments, offer efficiency, profitability and significant cost saving in many applications otherwise requiring a variety of specific machines.

The features and performance of Merlo attachments, together with their total compatibility with the machines, result from an integrated in house design and manufacturing process.

The heart of the system is the Merlo carriage, which mates the huge variety of attachments with the telescopic boom of the machine. All Merlo attachments are easily fitted to the carriage with an exclusive 'Tac-Lock' quick coupling system – much more 'use-friendly' than conventional manual coupling system. It takes just a few seconds to connect the attachment, almost instantly adapting the base machine to changing lifting, digging, transport, loading/unloading, and precision handling needs. This brochure illustrates the many uses added by fitting attachments, some of them specifically designed for the individual application, from all over the world.

Warning: National Regulations Operator Training requirements and Certification can differ and some attachments shown may not be available in every country. Attachments may require pre-arrangement of the host machine and, in some cases, there is not a retro fit option. Always check with your Merlo dealer!

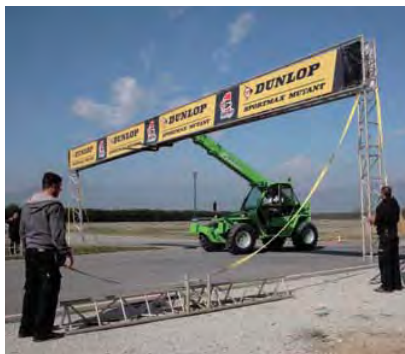
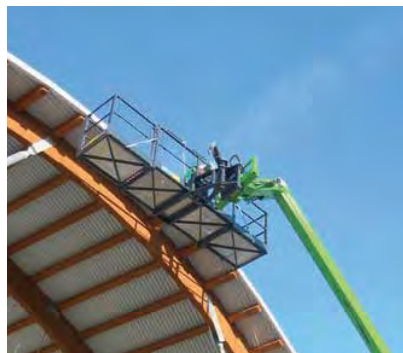



Forks



Manure fork and grab

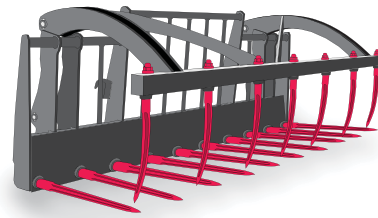

Folding hay bale spikes

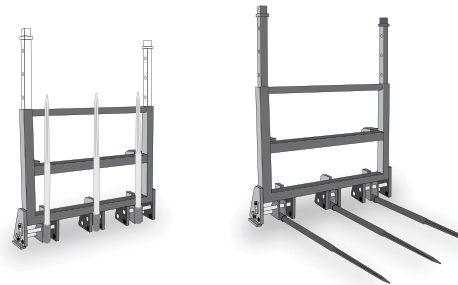

Folding hay bale spikes and sliding backrest

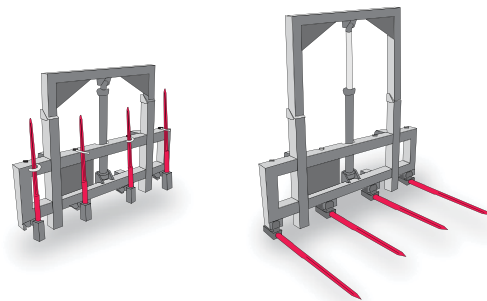

Folding hay bale spike with top spike

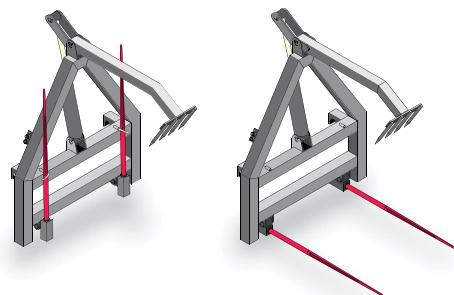

CLAMPS



Manure fork

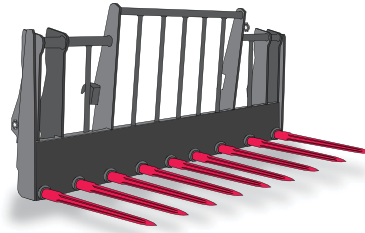

Twin log clamp



Drum clamp

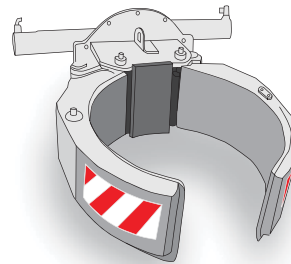

Round bale clamp

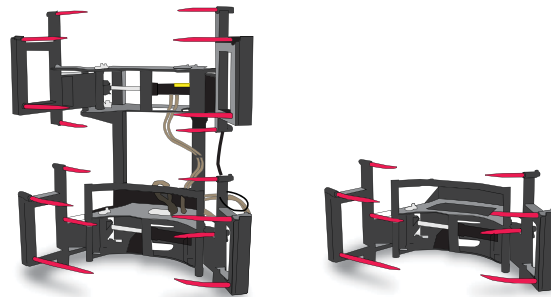

Wrapped round bale clamp

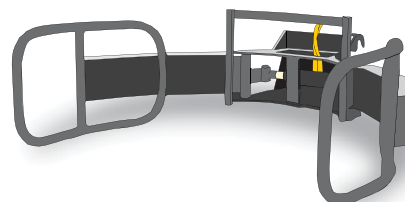



Orange-peel grab

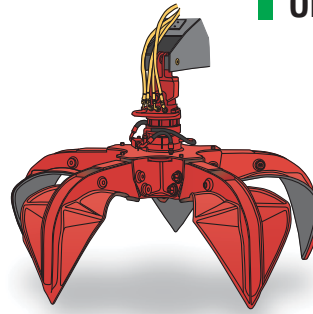

360° rotating grab



360° rotating cement pipe grab

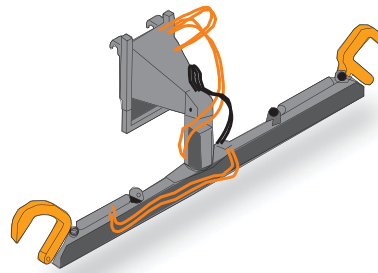

Paper or waste squeeze clamp

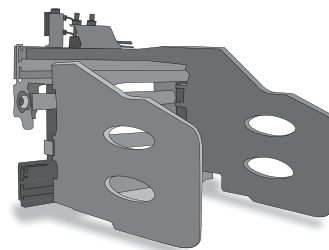

Tyre handler

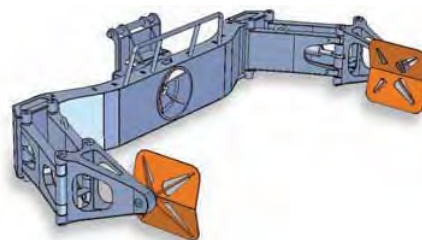

BUCKETS



Olive tree shaker

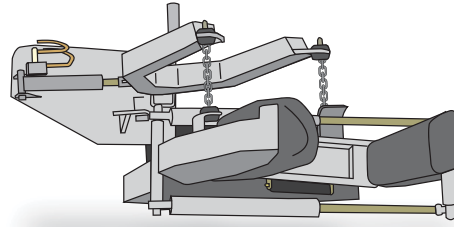

Digging bucket

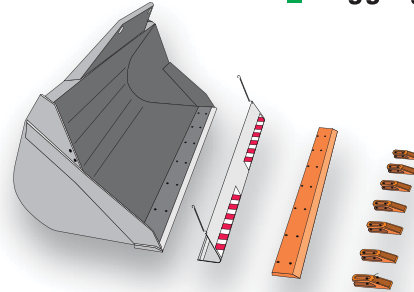

Re-handling bucket

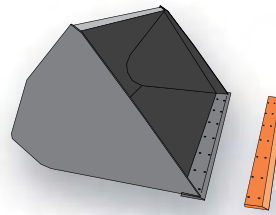

4 in 1 bucket

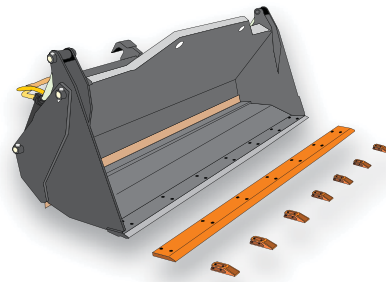

4 in 1 cereals bucket

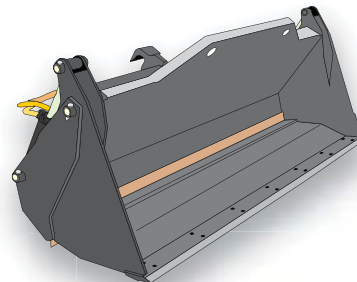



General purpose bucket and grab

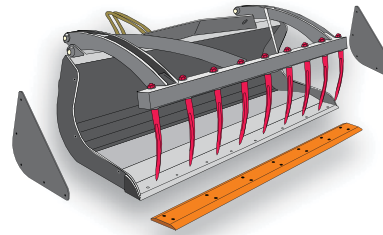

Root crop bucket

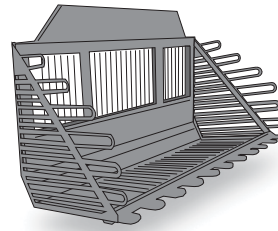

Waste bucket

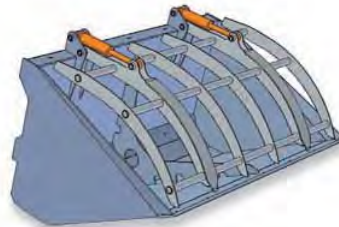

Timber bucket

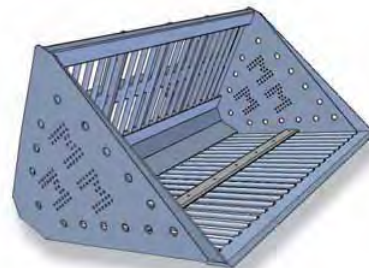

Bottom discharge bucket

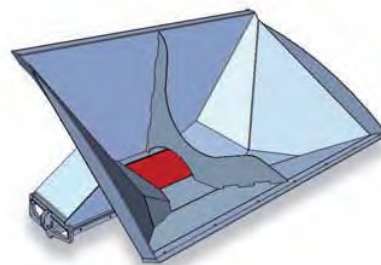



Concrete skip

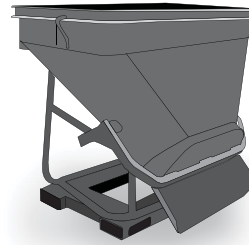

Concrete mixing bucket

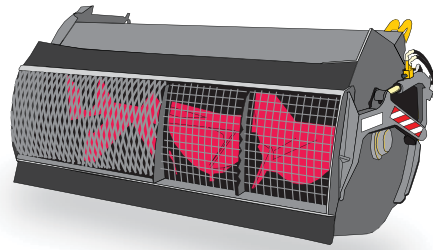

Brick handler



Fork-mounted hook

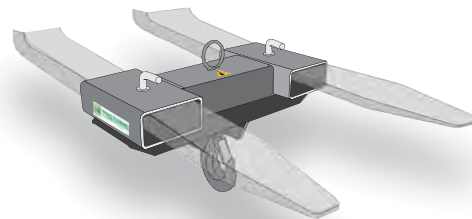

Carriage-mounted hook

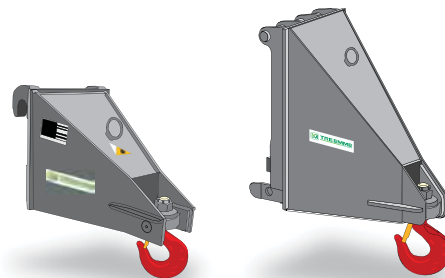



Crane jib

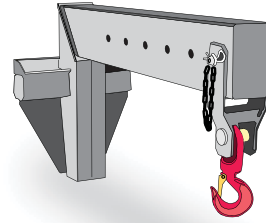

Telescopic crane jib

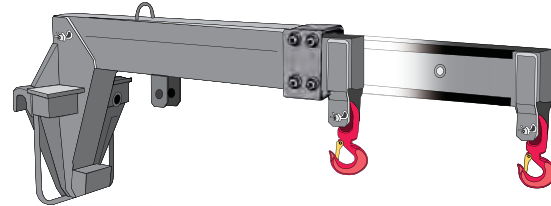

Lattice jib

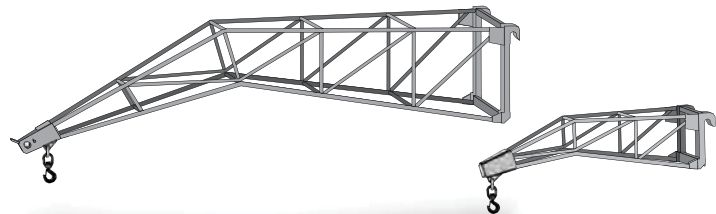

Lattice jib with winch

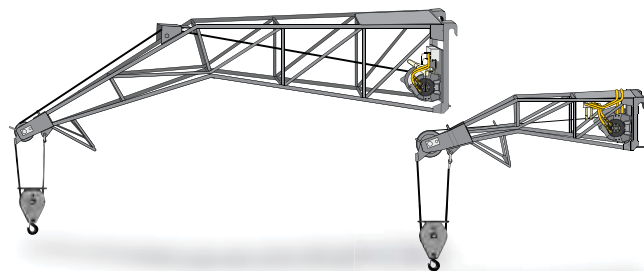

Mini Tower Jib





Carriage-mounted winch

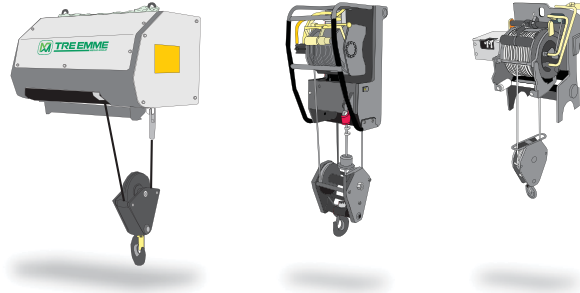

Carriage-mounted jib

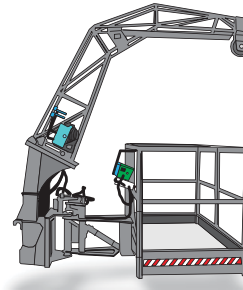

Carriage-mounted hoist

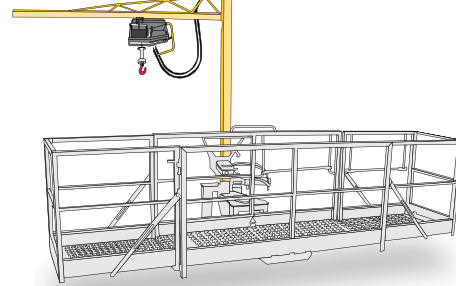

Marble slab carrier

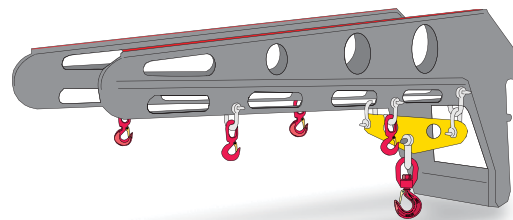

Boom-mounted winch





Multifarmer winch and anchor

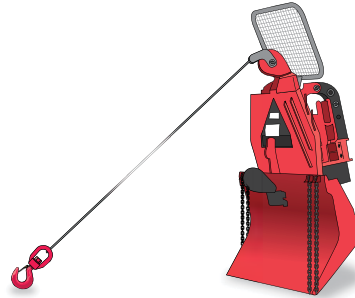

Fixed platform

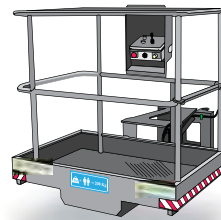

Slewing platform

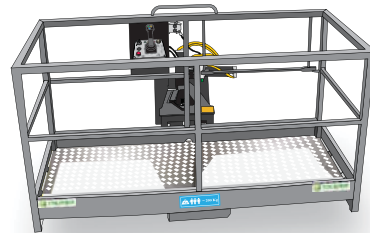

Extendible slewing platform

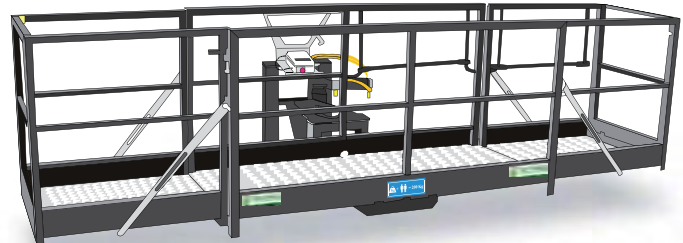

Front-opening slewing platform

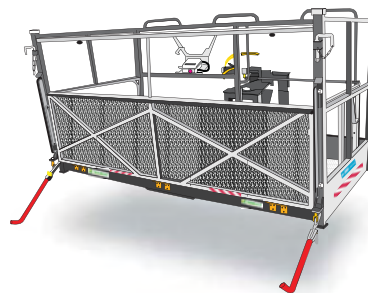

PLATFORMS



Space 11 platform



Tunnel rib positioning system with Space platform





Platform with tunnel rib positioning boom



Tunnel rib transport boom

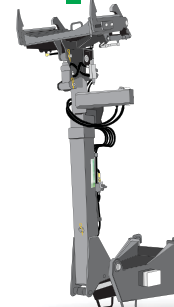

Platform with overhead protection



Panel positioner

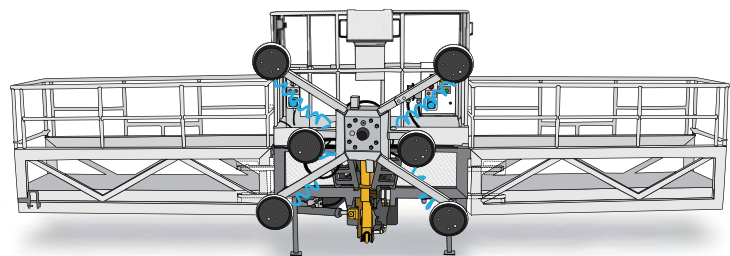

Insulating tower

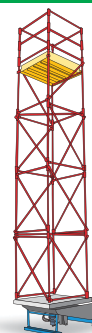

SPECIAL TOOLS



Boat handler

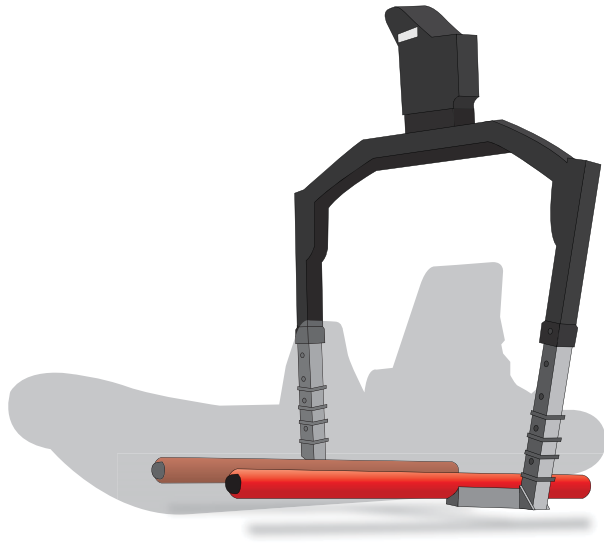

Sweeper

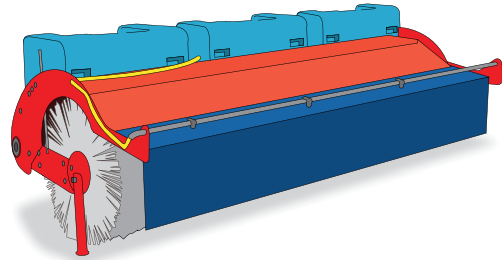

Disk bush cutter

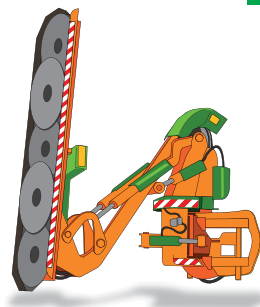

Ice coring machine

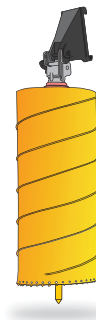



Drilling rig

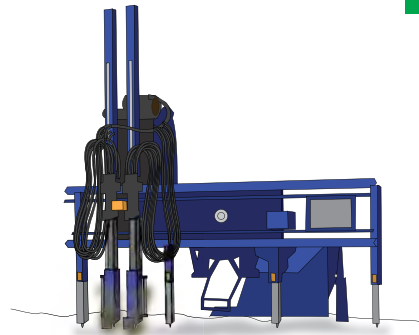

Block paving compaction system

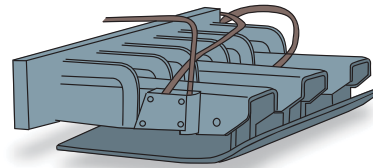

Snowploughs for snow removal

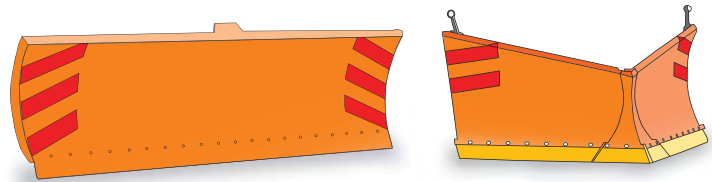

Pushing blade

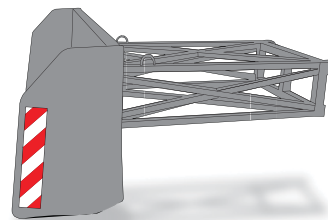

Hydraulic hammer

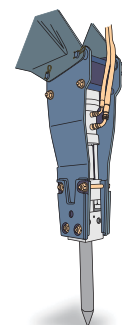

Merlo Group the supremacy of ideas.

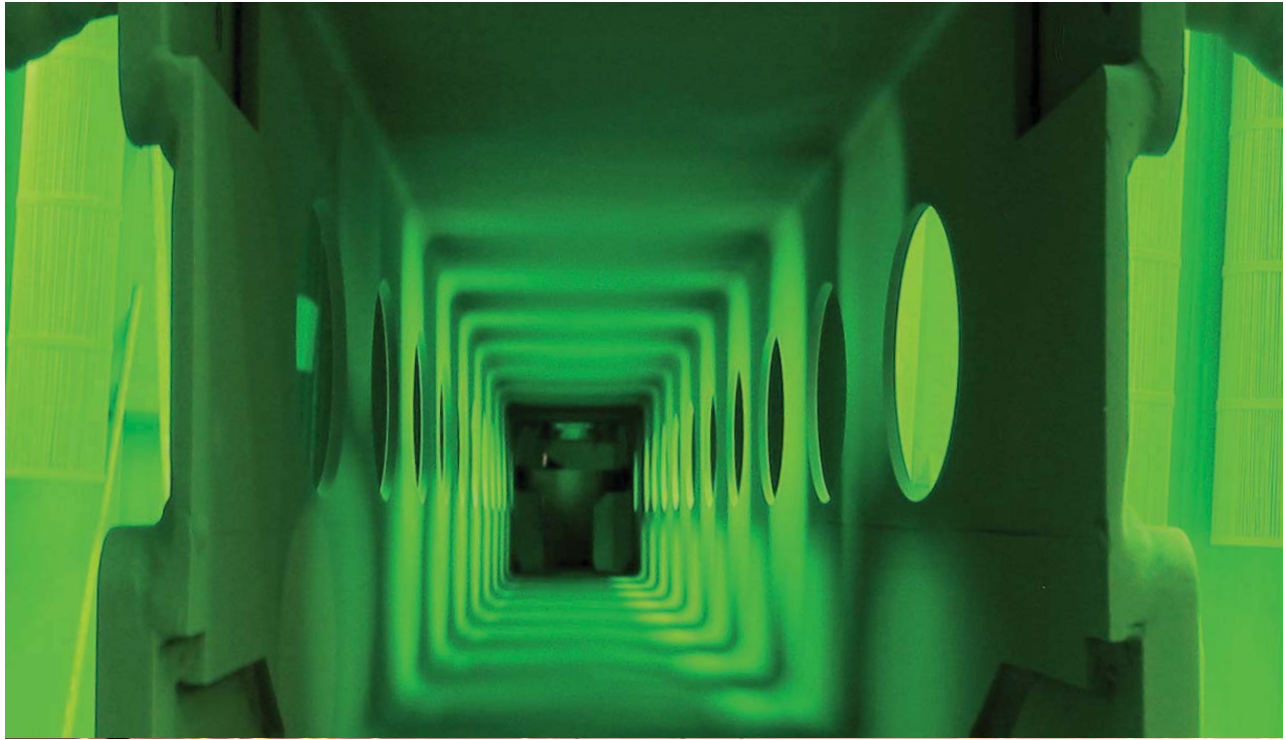

Telescopic boom. Powder painting.

The Merlo brand is synonymous for innovation and technology in the world of telescopic handlers.

The history of the Merlo Group is punctuated with ideas, drive and passion. The whole Group revolves around these values, providing the base for the success of new products, as well as of the numerous international awards the company has been awarded.

Developing complex projects, from ideas to results and from design to sales, implies proposing innovative solutions which become the forerunners of new trends and applications in the most competitive markets.

This is a winning attitude which is seen in the drive for an integrated manufacturing process with the most modern construction methods, automatic processes, integrated electronics, robotics handling and much, much more.

Our will to maintain a closer and closer bond with our customers is reflected in training and refresher courses, in after-sales service, and in trust-based relationships with our dealers worldwide.

The results are compact and manoeuvrable machines which ensure unrivalled levels of comfort, efficiency and safety.

This is the strength of the Merlo Group.



Building with confidence.



MERLO S.p.A. Via Nazionale, 9 - 12010 - S. Defendente di Cervasca - Cuneo - Italia
Tel. +39 0171 614111 - Fax +39 0171 684101 - www.merlo.com - info@merlo.com

COMPANY
WITH QUALITY MANAGEMENT
SYSTEM CERTIFIED BY DNV
=ISO 9001:2000=