

new

28200 ASC

COMPANY QUALITY SYSTEM



Certified in accordance with the ISO 9001 norms and subject to voluntary and periodical inspections



CORMACH









... ABOUT ANCIENT

EGYPT MANUSCRIPTS



KRANKAMON, PHARAOH OF EGYPT, DREAMED ABOUT HIS PYRAMID, THAT IN HIS INTENT, SHOULD BECOME THE BIGGEST EVER BUILD.

"Phew! What hard work. Is it possible that anybody can think of a better pushing system?"



PHARAOH CORMSES, YEARS LATER, DREAMED THE SAME DREAM, OF THE BIGGEST PYRAMID BEING HIS OWN.

"Here is the solution: Cormach system whit roller bearing, faster and more efficient."

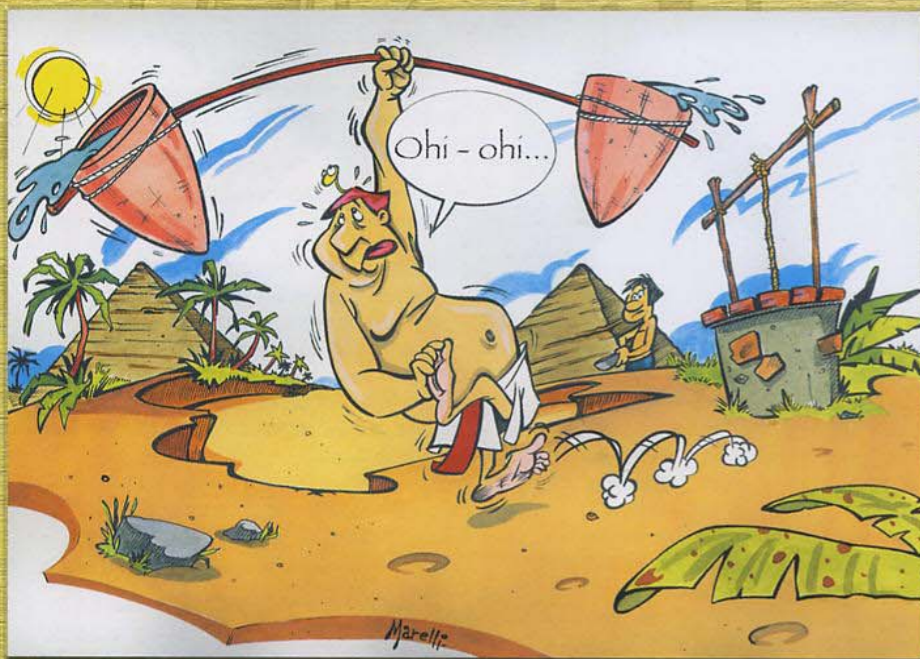

THE BUILDING PROCESS WAS SLOW BEING HIS RESOURCES LIMITED TO SLAVES AND MATERIAL.

"But, why is it such hard work using only one support?"



BEING OLD HE DECIDED TO FINISH KRANKAMON WORK, BUT THE NEEDED SOMETHING TO SPEED THE WORK UP.

"Here is the solution: Cormach system whit double mast and double lifting cylinders."

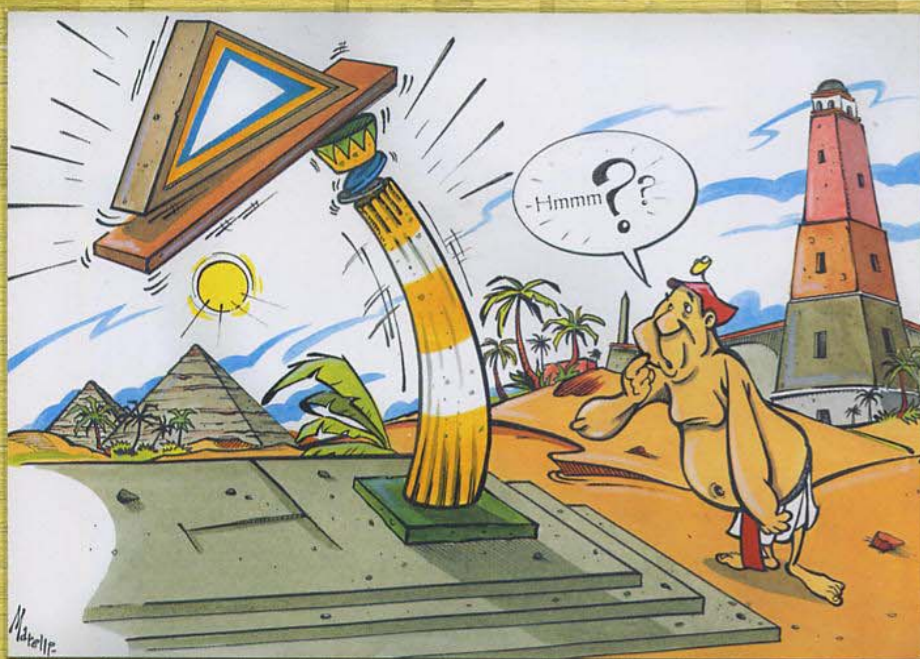

THE PHARAOH LIVED A SHORT AND HARD LIFE AND THE KRANKAMON PYRAMIDS REMAINED A DREAM.

"There is something illogical in this system. The offset boom unbalances the structure."

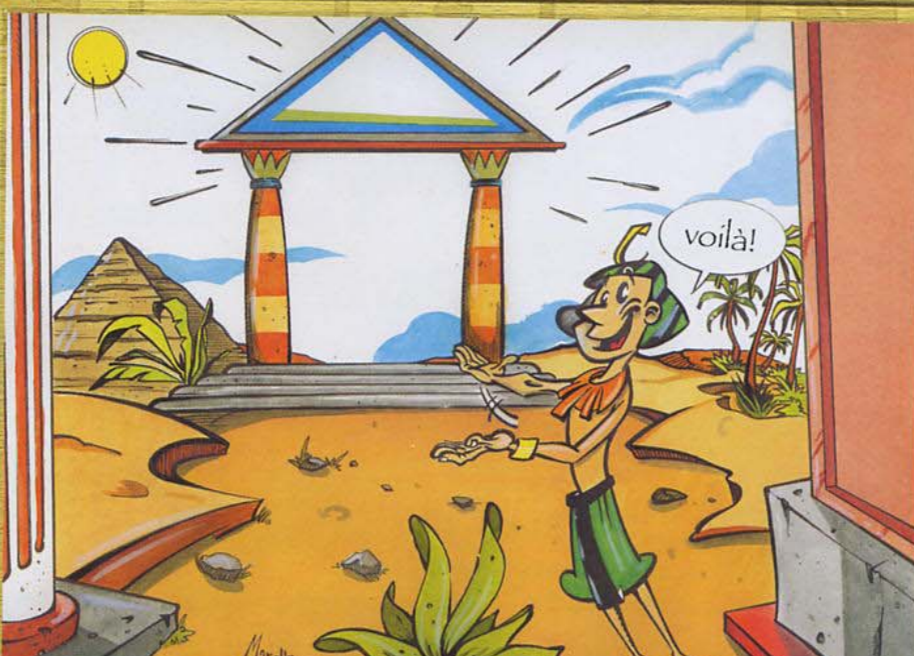

CORMSES DREAM CAME THROUGH AND HIS PYRAMID WILL STAND FOR EVER.

"Here is the solution: Cormach boom in central position makes the structure more balanced. Excellent."





- Compattezza: 20 m di braccio idraulico 27 t*m di capacità in uno spazio di 1x2.5x2.2 m
- Compactness: hydraulic operated forward reach 20 m. Capacity 27 t*m (195,329 lb*ft) with size 1x2.5x2.2 m (3'3"x8'2"x7'4")
- Compacité: rayon d'action hydraulique à 20 m. Capacité 27 t*m avec dimensions 1x2.5x2.2 m
- Kompakte bauweise: einbaumasse 1x2.5x2.2 m, bei einem hubmoment von 27 t*m und einer hydr. Reichweite von 20 m.
- Compacta 20 m. De brazo hidr(ulico 27 t*m de capacidad en un espacio de 1x2.5x2.2 m

- Il serbatoio e tutti i carter di protezione sono in acciaio inox. Un filtro d'aria e d'olio nel serbatoio assicura la massima pulizia dell'impianto.
- The oil tank as well as all other protections are made out of stainless steel. The oil is kept free of pollution by an air filter and a return line filter.
- Réservoir d'huile et carter de protection en acier inoxydable, avec filtres à air et à huile assurant le nettoyage du circuit hydraulique.
- Öltank und Schutzbleche sind aus Edelstahl Das Öl wird durch einen Luftfilter und einen Rück aufölfilter vor Verunreinigung geschützt.
- El deposito y todos los cartees de protección son de Acero Inox. Un filtro de aire y de aceite en el deposito asegura la máxima limpieza de la instalación.

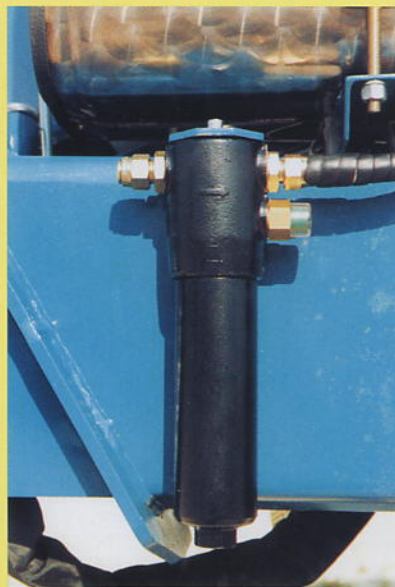

- Filtro ad alta pressione con spia luminosa di intasamento sul pannello di controllo.
- Warning light that informs the operator when the high pressure filter is clogged.
- Filtre haute pression avec témoin de colmatage sue le tableau de contrôle.
- Verschmutzungsanzeige des Hochdruckfilter durch Warnlicht.
- Filtro de alta presión con avisador luminoso de atascamiento en el panel del control.

- Braccio esagonale in materiale ultra resistente; rottura garantita minima pari a 980 n/mm² (140.000 psi) con una unica saldatura nella parte compressa.
- Hexagonal boom section made out of high strength steel. Minimum braking point equal to 980 N/mm² (140000 psi). The boom has only one welding.
- Bras à section hexagonale en acier haute résistance: rupture minimum garantie égale à 980 N/mm² (140000 psi) avec une seule soudure dans la partie comprimée.
- Hexagonalausleger (Sechskant) aus hochwertigem Feinkornstahl. Min. Zugfestigkeit 980 N/mm² (140000 psi). Der Ausleger hat nur eine Schweißnaht.
- Braço hexagonal de material ultraresistente; rotura mínima garantizada equivalente a 980N/mm² (140000 psi) con una unica soldatura en la parte comprimida.

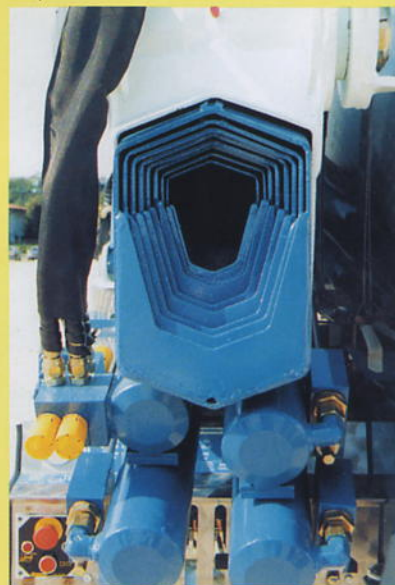

- Indicatore dello stato di carico con evidenziate le zone di preallarme e allarme come richiesto dalle normative internazionali.
- Load-status indicator with warning pre-warning indicator.
- Indicateur de l'état de la charge indiquant la zone de surcharge et d'approche de la surcharge selon les normes internationales.
- Lastmomentanzeiger mit automatischer Überlastvorwarnung.
- Indicador del estado de carga con evidencia de zonas de prealarma, según normativas internacionales.

- Tutte le parti in movimento ed i tubi sono ricoperti da pannelli di protezione come richiesto dalle normative sulla sicurezza.
- All moving parts as well as hoses are covered with protection panels.
- Toutes les parties mobiles ainsi que les tuyaux sont protégés par des panneaux de protection selon les normes de sécurité.
- Alle beweglichen Teile und alle Hydraulikschläuche sind durch Abdeckungen geschützt.
- Todas las partes en movimiento y los tubos están recubiertos de paneles de protección, según normativas de seguridad.



SERIE 28200 ASC

·Stabilizzatori extralarghi con cilindri di estensione protetti.
·Wide outriggers extension with protected cylinders.
·Stabilisateur avec grande extension et verins protégés.
·Grosse abstützbreite mit abgedekten abstützylindern.
·Estabilizadores super-anchos martinetes de extension protegidos.

·Limitatore di momento per prevenire sovraccarichi accidentali in opzione.
·Overload protection, to prevent overloading (option).
·Limiteur de capacité pour prevenir surcharges (option).
·Zur Vermeidung von Überlast der Kran kann mit einer Überlast-abschaltvorrichtung ausgerüstet werden.
·Limitador de momento para evitar sobrecargas (option)

·Bocche in materiale autolubrificante.
·Bushes made in selflubricating material.
·Bagues en matériel auto-lubrifiant.
·Büchsen aus selbstschmierendem Material.
·Los casquillos están fabricados con material autolubrificante.

·Rotazione tramite motore idraulico, riduttore e freno ad intervento negativo, possibilità di avere la rotazione continua (in opzione). Kit rotazione 420° in opzione.
·The crane swings thanks to a rotation system made out of a hydraulic motor a negative disc brake and a gear box. The crane can be equipped with a continuous rotation system. (Option 420°).
·Rotation moteur hydraulique et réducteur avec frein hydraulique à action négative incorporé. En option: rotation continue ou 420°.
·Das Schwenkwerk wird über ein Getriebe durch einen Hydraulikmotor angetrieben. Gebremst wird es durch eine Scheibenbremse. Der Kran kann mit einem endlos drehbaren Schwenkwerk ausgerüstet werden. (Oder 420°).
·Rotación mediante motor hidráulico, reductor y freno de intervención negativa, posibilidad de obtener rotación continua o 420° (bajo pedido).

·Cuscinetto di base a rulli, massima resistenza, precisione di movimento, minimo attrito, nessuna usura.
·Highly resistant base roller bearing, outstanding motion precision, very little friction, no wear.
·Couronne à rouleaux pour obtenir résistance maximume, precision de mouvement, minimume friction et pas d'usure.
·Der schrägrollengelagerte Drehkranz ermöglicht feinfühligere Bewegungsabläufe, erzeugt niedrige Reibung und ist äusserst verschleissfest.
·Rodamientos de base en rodillos, máxima resistencia, precisión de movimientos y mínima fricción: ningún desgaste.

·Attacco al telaio oscillante in conformità alle specifiche dei maggiori costruttori di veicoli industriali.
·3 point linkage as required by the leading truck manufacturers.
·Atelage à trois points en conformité aux prescriptions des principaux constructeurs de véhicules industriels.
·3 punkt torsionsbrücke nach den aufbaubau-richtlinien der führenden LKW hersteller.
·Enganche al bastidor oscilante según recomiendan los principales constructores de vehículos industriales.

·Perni in acciaio speciale.
·Pins in special steel.
·Pivots en acier spécial.
·Balzen aus Spezialstahl.
·Pernos en aceri especial.

·Massima potenza, n. 2 cilindri di sollevamento per maggior resistenza.
·Outstanding power, 2 lifting cylinders granting higher resistance.
·Puissance maximume, nr.2 verins de levage pour obtenir plus résistance.
·2 Haupthubzylinder erzeugen eine gleichmässige Hubkraft und garantieren eine hohe Betriebssicherheit.
·Máxima potencia, n° 2 cilindros para levantar y para mayor resistencia.

·Braccio sagomato con sezione chiusa, massima resistenza a torsione e massima leggerezza della struttura.
·Shaped arm with closed section, max. resistance to torsional stress, and light structure.
·Bras façonné à coupe fermée permettant d'obtenir haute résistance à la torsion et structure très légère.
·Durch die geschlossene Konstruktion des Hubarmes, wird eine hohe Verdrehsteifigkeit bei geringem Eigengewicht erreicht.
·El perfil del brazo es de sección cerrada para alcanzar la máxima resistencia en los esfuerzos de torsión, con una estructura ligera.

·Corsa dei telescopici extralunga per uno sbraaccio massimo idraulico di 20 m (28200-E8 ASC).
·Telescopic cylinders with very long stroke for a maximum hydraulic range of 20 m (28200-E8 ASC).
·Course des verins télescopiques très longue pour une détente du bras hydraulique de mètres max. 20 m (28200-E8 ASC).
·Superlanger Teleskopauschub für eine Reichweite von 20 m (28200-E8 ASC).
·Carrera extra larga de los telescopios para una extensión hidráulica máxima de 20 m (28200-E8 ASC).

·Valvola flangiata sui cilindri per maggior sicurezza.
·Flanged valve on the cylinder for > safety.
·Soupape de sûreté flasquée sur les verins pour obtenir plus sécurité.
·Direkt geflanschte Ventile für ihre Sicherheit.
·Valvola antirretorno para mayor seguridad.

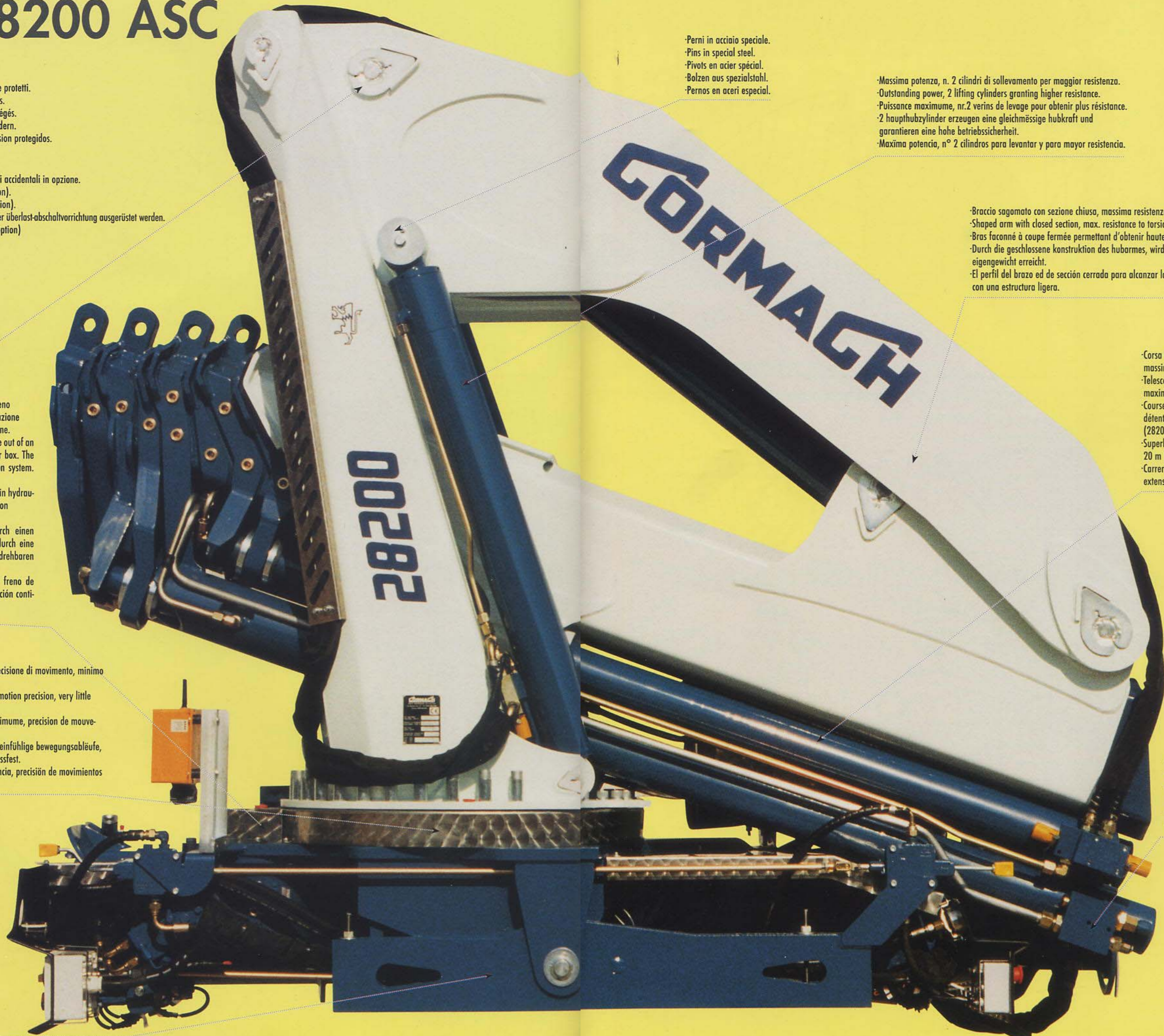



- In opzione alla gru è possibile richiedere una piattaforma di lavoro con la quale si può arrivare fino ad una altezza max. di 24 m.
- The crane can be equipped with a men basket. Max. working height 24 m.
- En option, la grue peut être équipée d'une nacelle pouvant atteindre une hauteur d'environ 24 m.
- Personenkorb als Zubehör lieferbar. Max. Arbeitshöhe: 24 m.
- Bajo pedido se puede conseguir una plataforma aérea de trabajo que puede llegar hasta una altura máxima de 24 m.

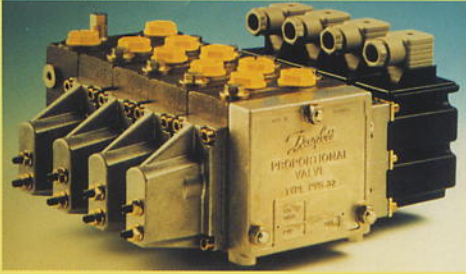

- Distributore proporzionale danfoss in opzione. Ottimizza il flusso di olio permettendo di compiere più manovre contemporaneamente.
- The crane can be equipped with a Danfoss proportional control valve (flow and pressure compensated). For more functions at the same time.
- En option, distributeur proportionnel DANFOSS.
- Der Kran kann auf Wunsch mit einem Danfoss multifunktion Proportional Ventil ausgerüstet werden.
- Distribuidor proporcional DANFOSS (bajo pedido).

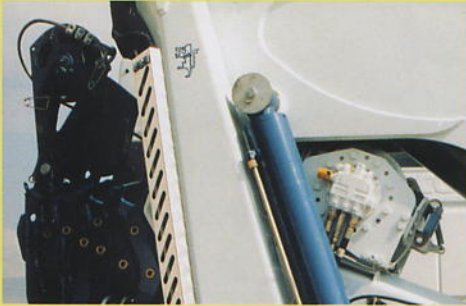

- Argano con fune antigiro da 1500 kg, possibilità di chiudere la gru senza smontare la testata
- The crane is equipped with a 1500 Kg winch with no spinning wire rope. The crane can be folded with installed horse head.
- Disponibile en option: treuil hydraulique, capacité 1500 Kg, avec câble anti-giratoire et possibilité de replier la grue sans démonter la tête de flèche.
- Der Kran kann mit einer 1500 kg Seilwinde (Option) ausgerüstet werden. Er kann mit dem montierten Rollenkopf zusammengelegt werden.
- Cabrestantes con cuerda antigiro de 1.500 kG, posibilidad de cerrar la grua sin desmontar la cabeza.



- Pannello di controllo con spia luminosa di intasamento filtro e conta-ore fondamentale per la programmazione della manutenzione.
- Instrument board with hour meter and filter clogging indicator. Fundamental for maintenance programming.
- Tableau de contrôle avec témoin de colmatage du filtre haute pression et compteur horaire. Cet équipement est fondamental pour la programmation des entretiens périodiques.
- Armaturenbrett mit Stundenzähler und Verschmutzungsanzeige des Hochdruckfilters. Unbedingt notwendig für eine sinnvolle Wartung des Krans.
- Panel de control con avisador luminoso de atascamiento filtro y cuenta horas, muy importante para la programación del mantenimiento.

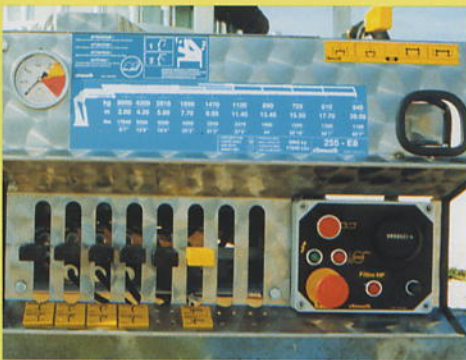

- Posto di manovra in armonia con tutte le normative riguardanti l'ergonomia e la sicurezza e completo di bolla per il posizionamento in piano della gru.
- Control board made in accordance with all norms for both ergonomic and safety. It is also equipped with a water level.
- Siège de commande sur colonne, en harmonie avec les normes de sécurité et d'ergonomie, complété d'un niveau à bulle.
- Die Bedienungselemente sind nach ergonomischen und sicherheitstechnischen Aspekten angeordnet. Zur Ausrichtung des Krans ist er mit einer Libelle ausgerüstet.
- Puesto de maniobra según normativas que se refieren a la ergonomía, seguridad y accesorio para el posicionamiento en plano de la grua.



- Radiocomando con raggio d'azione di 100 m (in opzione); completo di carica-batterie e di collegamento a cavo (senza emissione di onde radio) per uso in emergenza nel caso di mal funzionamento del radio o delle batterie.
- Radio remote control with 100 m. of working radius (option), equipped with battery charger, and cable (the sender controls the crane with cable, without emission of radio signals). The cable can be used in case of batteries failure.
- En option: radiocommande d'un rayon d'action de 100 m. Livrée avec chargeur de batterie et câble de raccordement de secours (sans ondes radio) pour utilisation dans les zones non autorisées en radiocommande ainsi qu'en cas de défaillance du mode radio.
- Auf Wunsch kann eine Funkanlage (100m Reichweite) geliefert werden. Sie ist zusätzlich mit einer Kabelsteuerung versehen werden (keine Funksignale). Dies ist notwendig um in der Nähe von Krankenhäuser etc. zu arbeiten.
- Radiomando con radio de acción de 100 mts. (bajo pedido); completa de carga-baterías y de botonera por cable (sin emisión de ondas radio) para uso de emergencia en caso de mal funcionamiento del radiomando o bien de las baterías.

Kabelsteuerung versehen werden (keine Funksignale). Dies ist notwendig um in der Nähe von Krankenhäuser etc. zu arbeiten.



- Certificazione totale dalla saldatura al prodotto finito.
- The welding procedure is fully certified and is regularly re-qualified.
- Certification totale depuis les soudures jusqu'au produit fini.
- Die Schweißverfahren sind zertifiziert. Die Prüfungen werden regelmäßig wiederholt.
- Certificación total desde la soldadura hasta producto terminado.

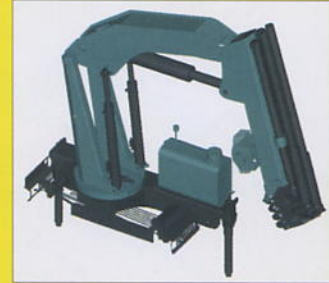

- Progettazione su CAD-3D.
- Engineered with 3D CAD.
- Projecté par CAD-3D.
- Berechnet mit 3D CAD.
- Projectada con CAD 3D.

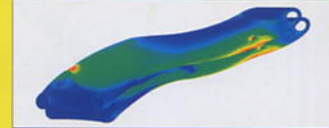

- Strutture verificate con calcolo ad elementi finiti.
- Structures are verified with finite elements calculation.
- Structure vérifiée par calculs préalables tenant compte des contraintes appliquées aux différents éléments en utilisation réelle.
- Die Struktur des Krans wurde mit finiten Berechnungen (3-D CAD) kalkuliert.
- Estructura verificadas con calculo de elementos acabados.

28200-E2 ASC

28200-E4 ASC

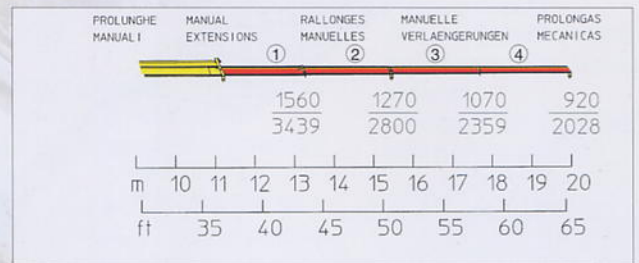
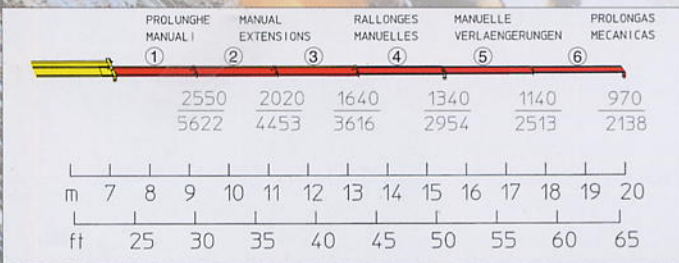
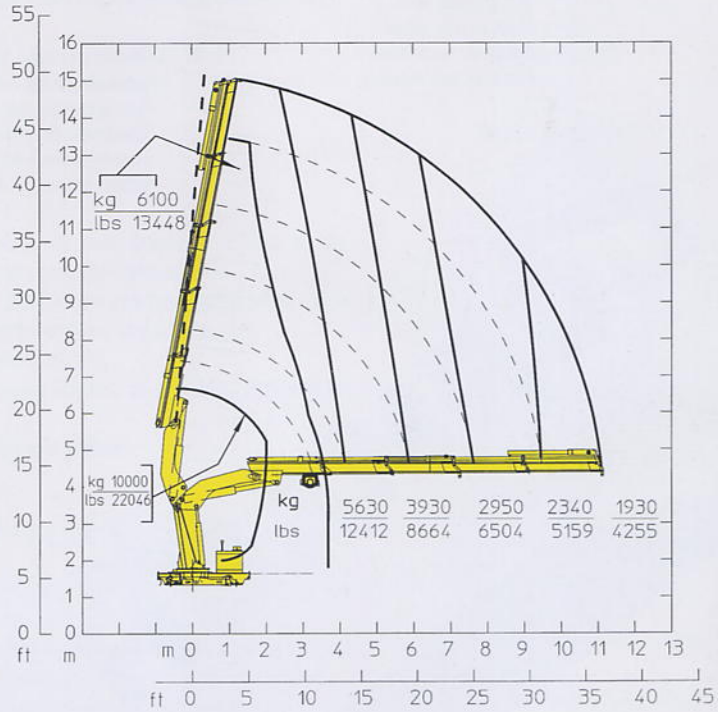
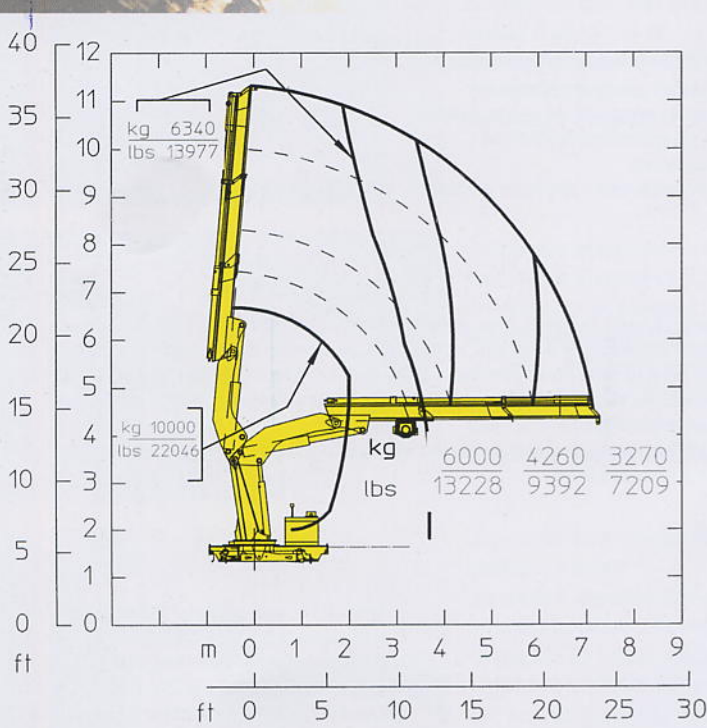

STANDARD



OPTIONAL

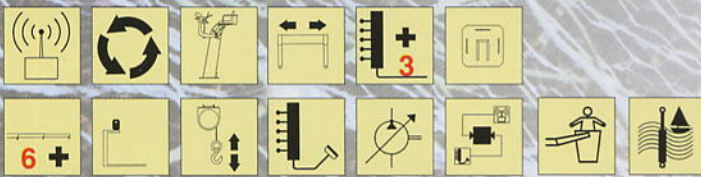

STANDARD



OPTIONAL

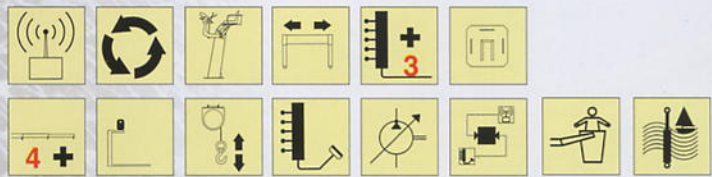

E2

28200 daN • m	223850 lbs • ft
7,40 m	24'3"
20,00 m	65'7"
2800 daN • m	20652 lbs • ft
40 sec - 360°	40 sec - 360°
1750-1750 mm	5'9"-5'9"
5838 mm	19'2"
1007 mm	3'4"
2500 mm	8'2"
2230 mm	7'4"
2710 Kg	5974 Lbs
45 lit / min	12 us gal / min
310 bar	4496 psi
155	41 us gal

E2

Momento statico massimo al perno torretta - Max. static moment at the turret pin - Moment statique max. à l'axe de la tourelle - Max. statisches Hubmoment am Kransaulenbolzen
Sbraccio idraulico - Hyd. boom length - Longueur du bras Hyd. - Hyd. Reichweite
Sbraccio con prolunghe manuali - Boom length with manual extensions - Longueur du bras avec rallonges manuelles - Auslegerlänge - Longitud del brazo hidráulico con prolongas manuales
Coppia di rotazione - Slew torque - Moment de rotation - Drehmoment
Tempo di rotazione - Slewing speed - Temp de rotation - Schwenkgeschwindigkeit
Uscita stabilizzatori - Outriggers extension - Sortie des bequilles - Breite der Abstützung
Larghezza stabilizzatori - Outriggers width - Largeur des bequilles - Gesamtbreite der Abstützung
Lunghezza - Outriggers - Largeur - Gesamtbreite - Ancho
Larghezza - Width - Largeur - Breite
Altezza - Height - Hauteur - Höhe
Peso (senza olio e montaggio) - Weight (without oil and fitting) - Poids (sans huile et montage) - Gewicht (ohne Öl und ohne)
Portata pompa - Pump delivery - Capacité de la pompe - Pumpenleistung
Pressione - Pressure - Pression - Druck
Capacità serbatoio olio - Oil tank capacity - Capacité du réservoir d'huile - Öl tank inhalt - Acete

E4

28200 daN • m	223850 lbs • ft
11,30 m	37'1"
20,00 m	65'7"
2800 daN • m	20652 lbs • ft
40 sec - 360°	40 sec - 360°
1750-1750 mm	5'9"-5'9"
5838 mm	19'2"
1007 mm	3'4"
2500 mm	8'2"
2230 mm	7'4"
3030 Kg	6680 Lbs
45 lit / min	12 us gal / min
310 bar	4496 psi
155	41 us gal

28200-E6 ASC

28200-E8 ASC

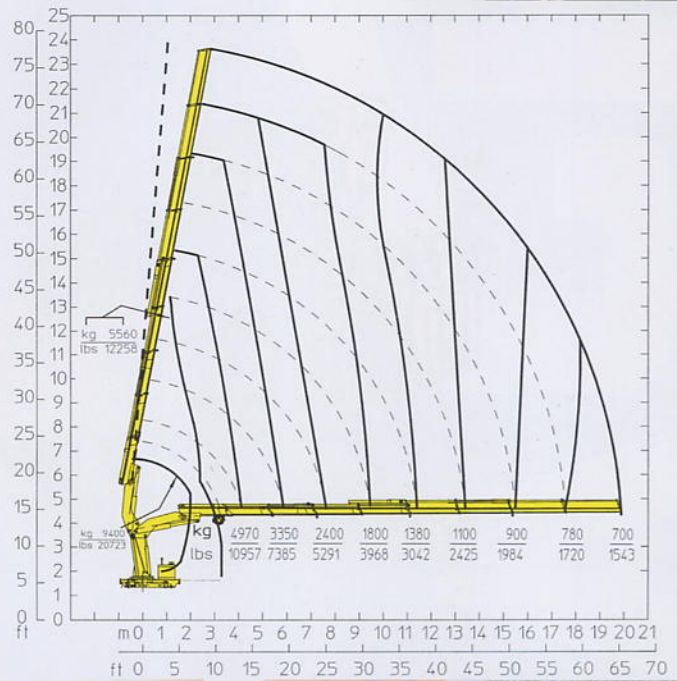
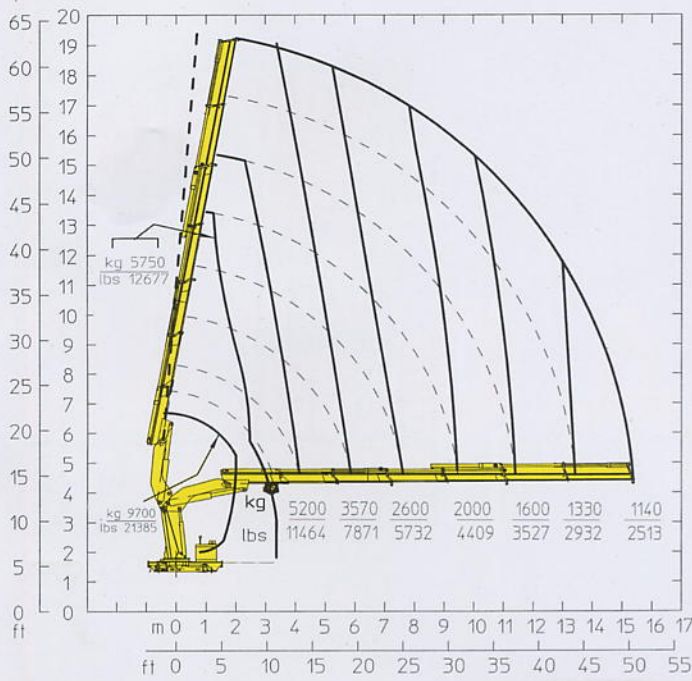

PROLONGHE MANUALI	MANUAL EXTENSIONS	RALLONGES MANUELLES	MANUELLE VERLÄNGERUNGEN (1)	PROLONGAS MECANICAS (2)
		960 800 2116 1764		
		m 13 14 15 16 17 18 19 20 ft 45 50 55 60 65		

STANDARD



OPTIONAL

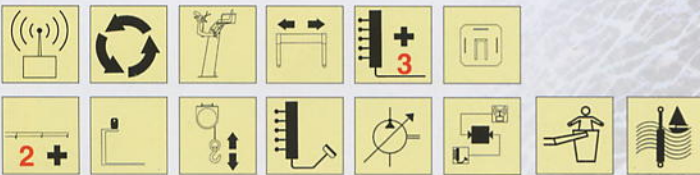

STANDARD



OPTIONAL

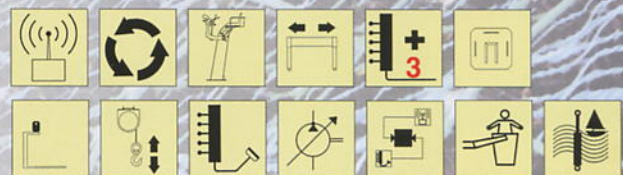





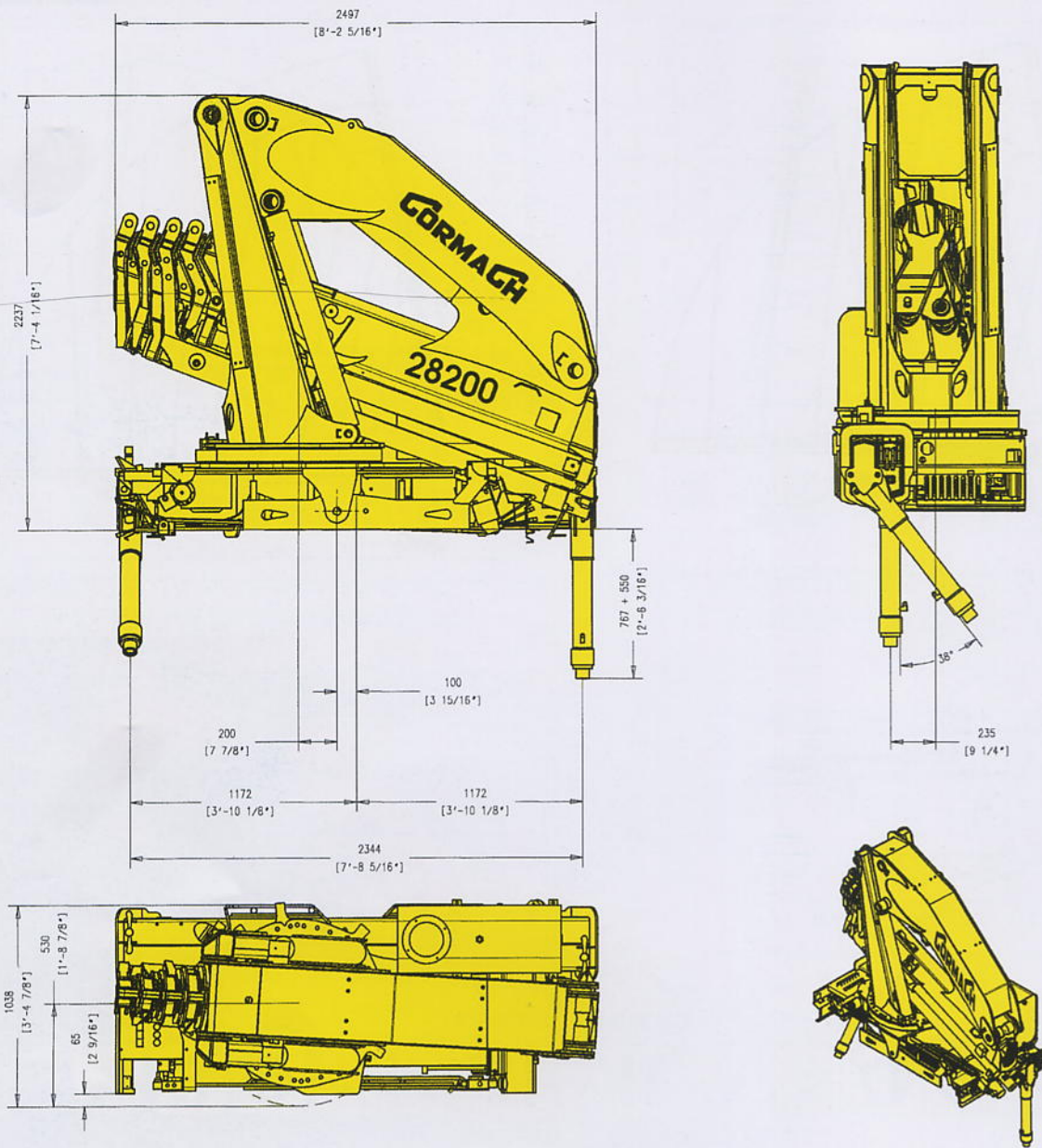

E6	E6		E8	E8
28200 daN • m	223850 lbs • ft	Momento statico massimo al perno torretta - Max. static moment at the turret pin - Moment statique max. à l'axe de la tourelle - Max. statisches Hubmoment am Kransaulenbolzen	28200 daN • m	223850 lbs • ft
15,50 m	50'10"	Sbraccio idraulico - Hyd. boom length - Longueur du bras Hyd. - Hyd. Reichweite	20,00 m	65'7"
20,00 m	65'7"	Sbraccio con prolunghe manuali - Boom length with manual extensions - Longueur du bras avec rallonges manuelles - Auslegerlänge - Longitud del brazo hidráulico con prolongas manuales	/	/
2800 daN • m	20652 lbs • ft	Coppia di rotazione - Slew torque - Moment de rotation - Drehmoment	2800 daN • m	20652 lbs • ft
40 sec - 360°	40 sec - 360°	Tempo di rotazione - Slewing speed - Temp de rotation - Schwenkgeschwindigkeit	40 sec - 360°	40 sec - 360°
1750+1750 mm	5'9"+5'9"	Uscita stabilizzatori - Outriggers extension - Sortie des bequilles - Breite der Abstützung	1750+1750 mm	5'9"+5'9"
5838 mm	19'2"	Larghezza stabilizzatori - Outriggers width - Largeur des bequilles - Gesamtbreite der Abstützung	5838 mm	19'2"
1007 mm	3'4"	Lunghezza - Outriggers - Largeur - Gesamtbreite - Ancho	1007 mm	3'4"
2500 mm	8'2"	Larghezza - Width - Largeur - Breite	2500 mm	8'2"
2230 mm	7'4"	Altezza - Height - Hauteur - Höhe	2230 mm	7'4"
3340 Kg	7363 Lbs	Peso (senza olio e montaggio) - Weight (without oil and fitting) - Poids (sans huile et montage) - Gewicht (ohne Öl und ohne)	3560 Kg	7848 Lbs
45 lit / min	12 us gal / min	Portata pompa - Pump delivery - Capacité de la pompe - Pumpenleistung	45 lit / min	12 us gal / min
310 bar	4496 psi	Pressione - Pressure - Pression - Druck	310 bar	4496 psi
155	41 us gal	Capacità serbatoio olio - Oil tank capacity - Capacité du réservoir d'huile - Öl tank inhalt - Aceite	155	41 us gal

GORMACH 28200-E8 ASC



-A fronte di una continua ricerca tecnologica i dati possono cambiare senza preavviso. Contattare il nostro Ufficio Commerciale per ulteriori informazioni.
 -Because of continuous technology research data can change without notice. Please, contact our Commercial Dept. for further information.
 -A cause de une continue recherche technologique les données peuvent changer sans préavis. Contacter notre Bureau Commercial pour des autres informations.
 -Irrtum und technische Änderung vorbehalten. Unser Vertrieb erteilt Ihnen gerne weitere Auskünfte. Bitte rufen Sie uns an.
 -Debito a los continuos avances tecnológicos los datos pueden variar sin notificación previa. Para más información rogamos contactar nuestro Departamento Comercial.

STANDARD

-  Comandi bilaterali
Dual control stations
Commandes à gauche et à droite
Beidseitige Bedienung
Mandos bilaterales
-  Stabilizzatori gru base girevoli
Tilt up outriggers
Stabilisateurs tournant
Drehbare Stützen
Estabilizadores giratorios de la grua base
-  Stabilizzatori gru base estendibili idraulicamente
Outriggers with hydraulic extension
Stabilisateurs avec extension hydraulique
Hydraulisch ausfahrbare Stützen
Estabilizadores grua base desplegables hidráulicamente
-  Rotazione 360°
Rotation 360°
Rotation 360°
Drehbereich 360°
Rotación 360°
-  Comando supplementare non attivato
Additional free section not activated
Section du distributeur pas activée
Zusätzlicher steuerschieber
Mando auxiliar no activado
-  Limitatore di momento
Load limiting device
Limiteur de charge
Überlastabschaltung
Limitador de momento (de carga)

OPTIONAL

-  Radiocomando
Radio remote control
Radiocommandes
Funkfernsteuerung
Radiomando
-  Comando supplementare attivato
Additional function
Section du distributeur activée
Zusatzfunktion
Mando auxiliar activado
-  Utilizzo con attrezzo
Additional accessories
Utilisation avec accessoire
Zubehör
Accesorios auxiliares
-  Predisposizione radiocomando telecomando
Predisposition for remote control by cable or radio
Predisposition pour la radio commande-telecommande par cable
Teilweise vorbereitet für funk- und kabel fernsteuerung
Preparado para radiomando-telemando por cable
-  Rotazione continua
Continuous rotation
Rotation continue
Endlos Schwenkwerk
Rotación continua
-  Piastre maggiorate
Large ground plates
Plaques stabilisateurs
Bodenplatten
Placas estabilizadoras de suelo de gran tamaño
-  Verricello
Winch
Treuil
Seilwinde
Cabrestante
-  Castello
Basket
Nacelle
Personenkorb
Cesta
-  Posto di manovra in alto
Top seat
Siege en haut
Hochsitz
Puesto de maniobra en alto
-  Trattamento marino della gru
Marine treatment of the crane
Traitement marin de la grue
Marine behandlung des Kranes
Tratamiento especial marino de la grua
-  Telecomando
Cable remote control
Telecommandes
Kabelfernsteuerung
Control remoto
-  Pompa a portata variabile
Pompe with load sensing
Pompe à débit variable
Verstellpumpe load sensing
Bomba de caudal variable
-  Prolunghe meccaniche
Manual extensions
Rallonges manuelles
Manuelle Verlängerungen
Prolongas mecánicas

Cormach s.r.l. - Via Madonnina, 27
 C.P. 199 - 25018 MONTICHIARI (BS) - ITALY
 Tel. +39/030/9656811
 Telefax + 39/030/9656846-7-8
 Web: <http://www.cormach.com>
 E-mail: info@cormach.com

GORMACH