

# CORMAGH

# 34000 E

A.S.C. plus **EVO**



Quality Management  
ISO 9001  
[www.dekra-seal.com](http://www.dekra-seal.com)



[www.cormach.com](http://www.cormach.com)



# ... ABOUT ANCIENT

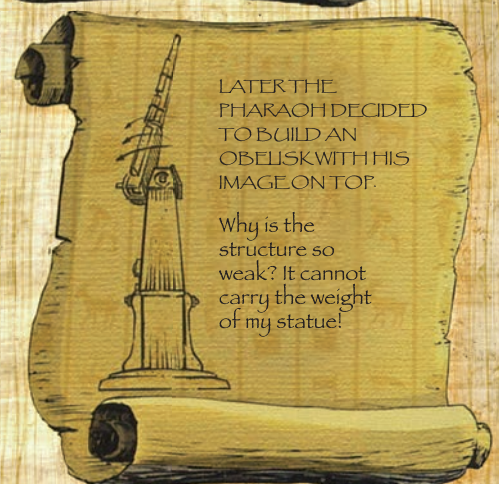
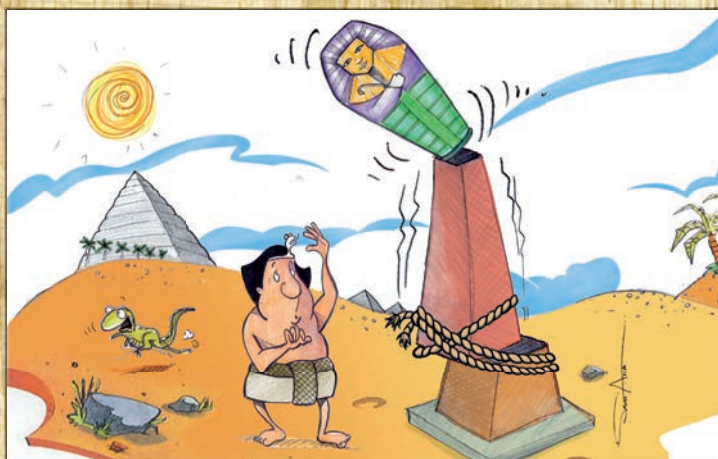
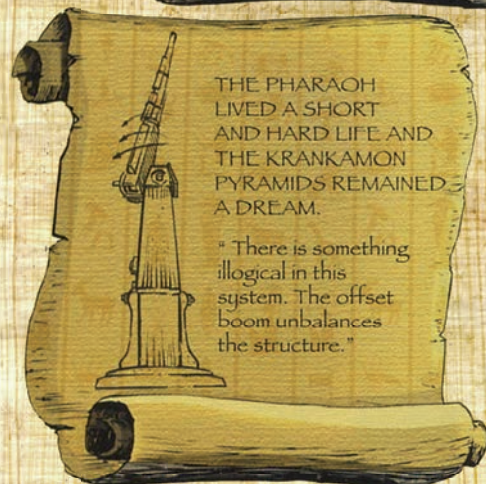
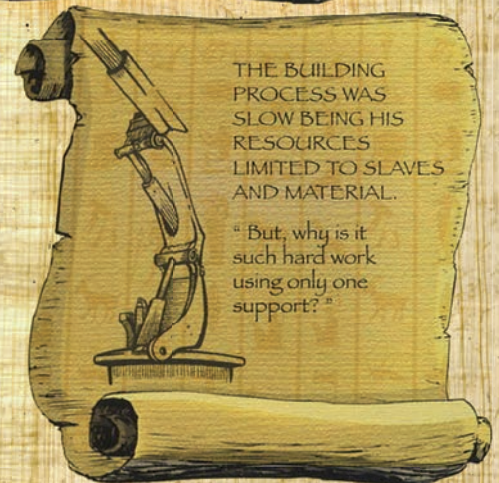
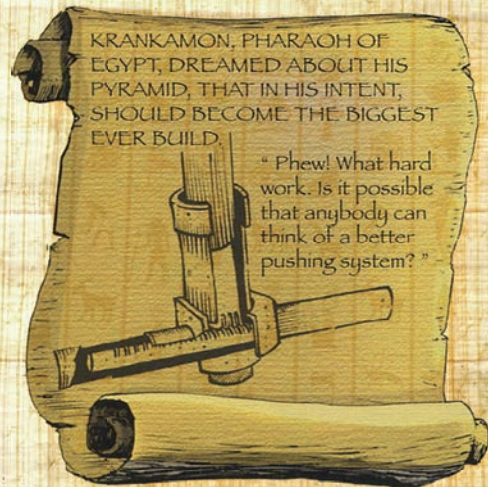



# EGYPT MANUSCRIPTS

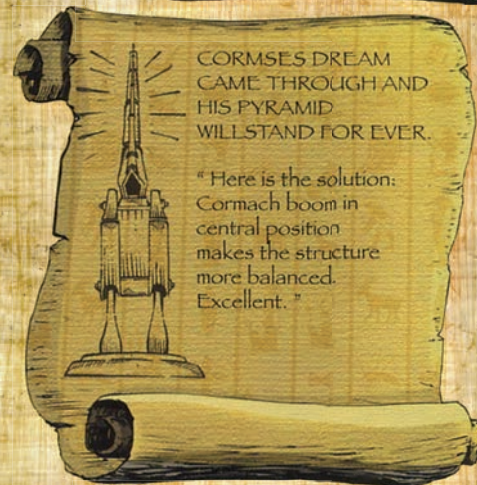
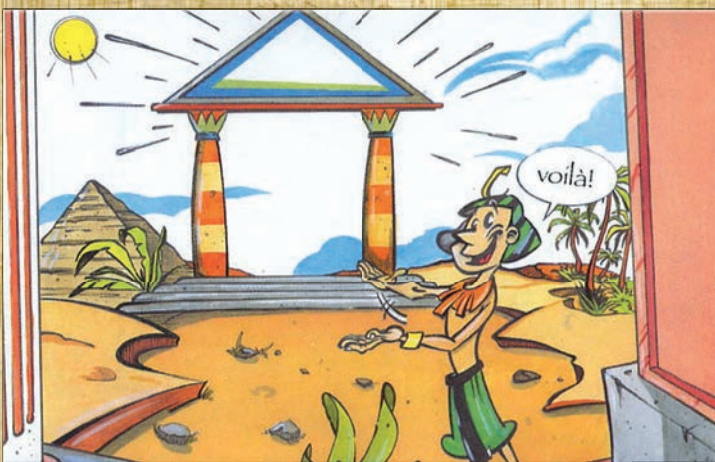
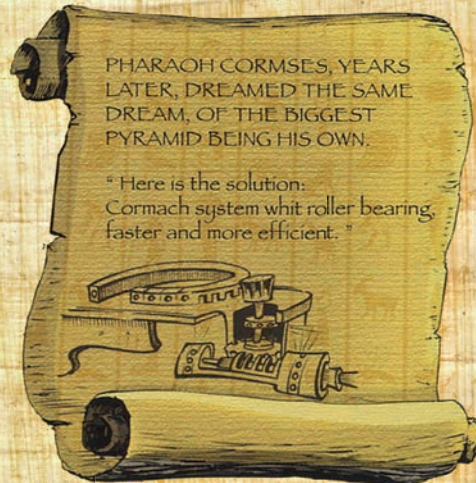



# 34000 E A.S.C. PLUS **EVO**



Radiocomando di serie.  
*Radio remote control.*  
Radiocommande de série.  
*Funkfernsteuerung serienmäßig.*



Angolo negativo tra 1° e 2° braccio (20 gradi).  
*Negative angle between 1<sup>st</sup> and 2<sup>nd</sup> boom (20 degrees).*  
Angle négatif entre 1<sup>ère</sup> et 2<sup>ème</sup> bras (20 degrés).  
*Negativ Winkel zwischen ersten und zweiten Arm (20 Grad).*



Sistema ritenzione cilindri gru chiusa.  
*Cylinders locking system when crane is folded.*  
Système de retenue vérin à grue ferme.  
*Halterung System mit zusammengelegten Kran.*



Verricello tiro diretto 2500 daN (OPZIONE).  
*2500 daN Winch on first line (OPTIONAL).*  
Treuil de tir direct 2500 daN (OPTION).  
*2500 daN Winde am ersten Seil (Auf Frage).*



Comandi accessibili da terra. Tutti i carter in acciaio inox AISI 304.  
*Controls can be reached standing on the side. All the carters are in stainless steel AISI 304.*  
Commandes accessibles de terre. Tous les carter sont en acier inox AISI 304.  
*Von der Seite steuerbar. Schutzplatten in Edelstahl AISI 304.*



Distributore proporzionale DANFOSS.  
*DANFOSS proportional control bank.*  
Distributeur proportionnelle DANFOSS.  
*DANFOSS proportional Steuerventil*



Scambiatore di calore.  
*Heat exchanger.*  
Echangeur de chaleur.  
*Ölkühler.*





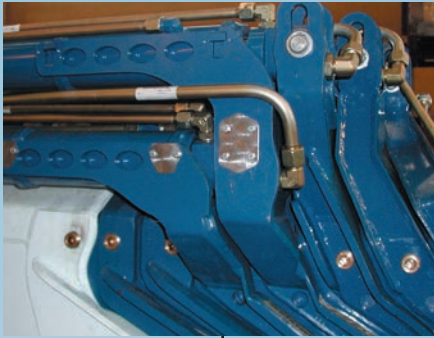

Tutti i cilindri a sfilo singolo. Con sfilo ad alta velocità (STANDARD). Con circuito FULL POWER, massima potenza (OPZIONE).  
 All the cylinders with single extension. High speed extension (STANDARD). With FULL POWER circuit, greatest power (OPTIONAL).  
 Tous les cylindres à extension individuel. Avec extension à vélocité élevé (STANDARD). Avec circuit FULL POWER, maximum puissance (OPTION).  
 Einzel Ausschulzylinder. Verlängerung mit Hochgeschwindigkeit (SERIENMÄSSIG). FULL POWER System für maximale Leistung (auf Frage).

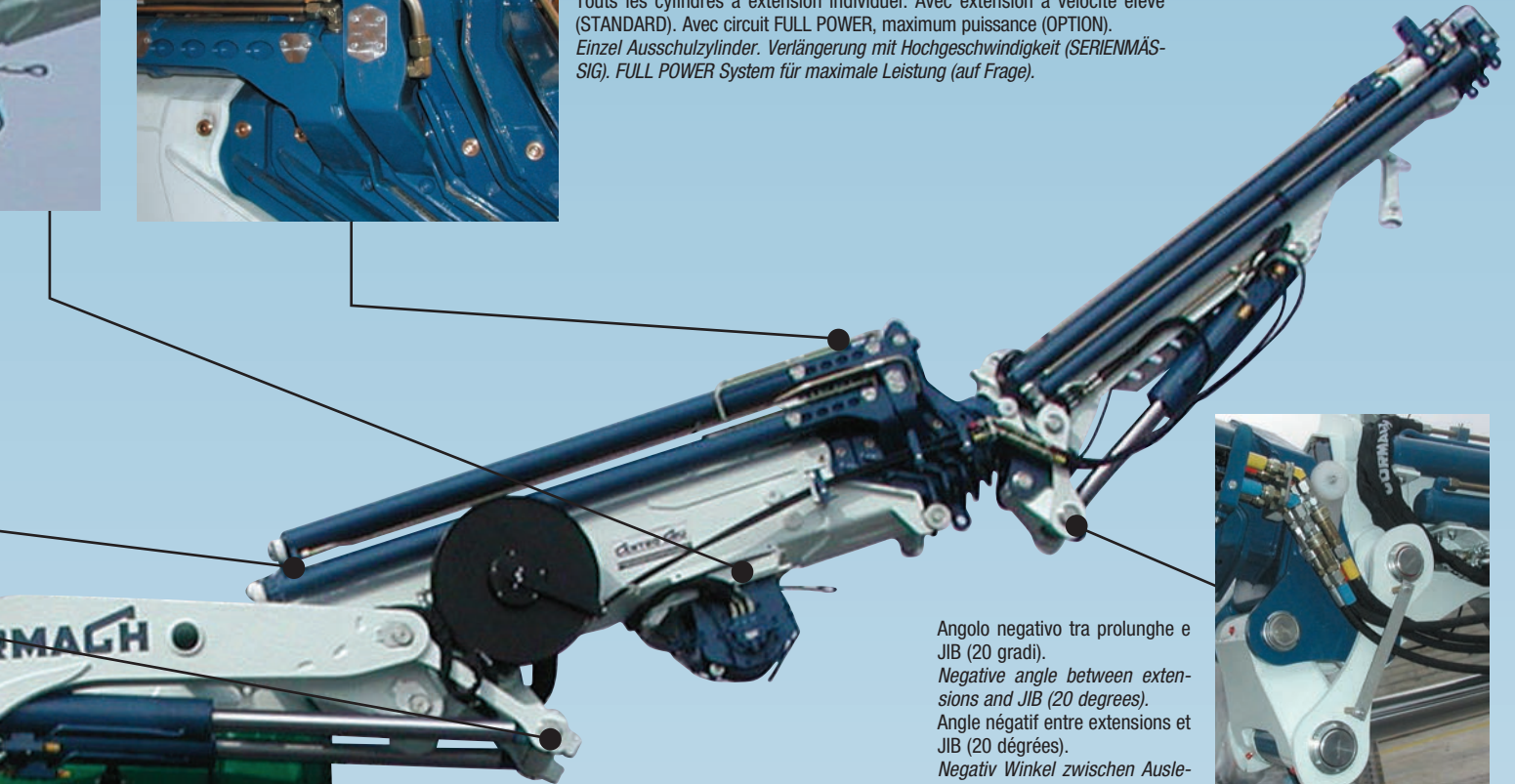

Angolo negativo tra prolunghe e JIB (20 gradi).  
 Negative angle between extensions and JIB (20 degrees).  
 Angle négatif entre extensions et JIB (20 degrés).  
 Negativ Winkel zwischen Ausleger und jib (20 Grad).

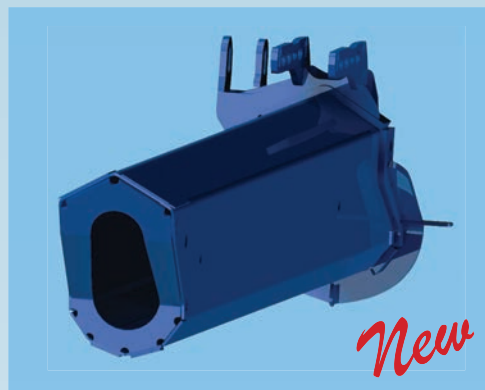
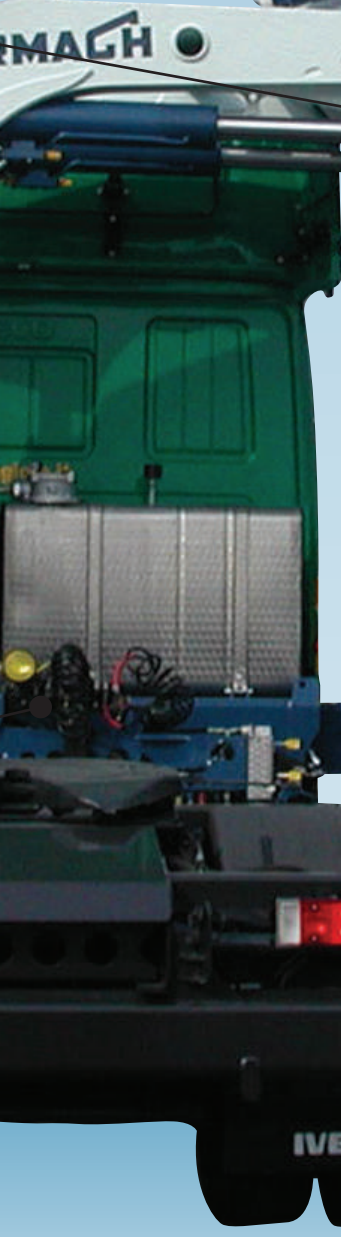

*New*

Sezione prolunghe di ultima generazione.  
 New generation extension profile.  
 Nouveau profil des extension hydrauliques (octogonal).  
 Verlaengerung-Schnitt neuer Generation



Cilindro stabilizzatore ribaltabile 180° (OPZIONE).  
 180 degrees tilting stabilising cylinder (OPTIONAL).  
 Cylindre stabilisateur escamotable 180 degrés (OPTION).  
 Stutzylinder kann 180° umgekippt werden (auf Frage).

IVECO



# 34000 E A.S.C. PLUS **EVO**









# 34000 E A.S.C. PLUS **EVO**

## 34000 E3

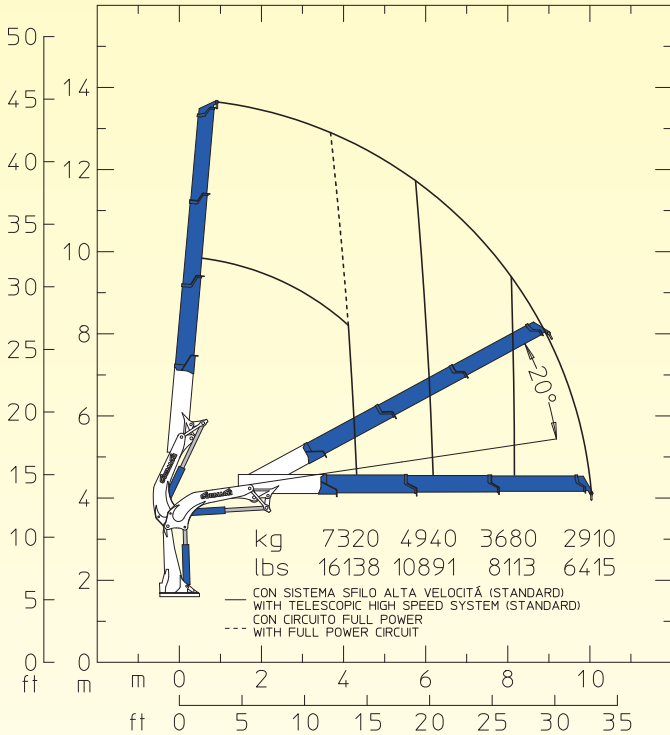

## 34000 E4

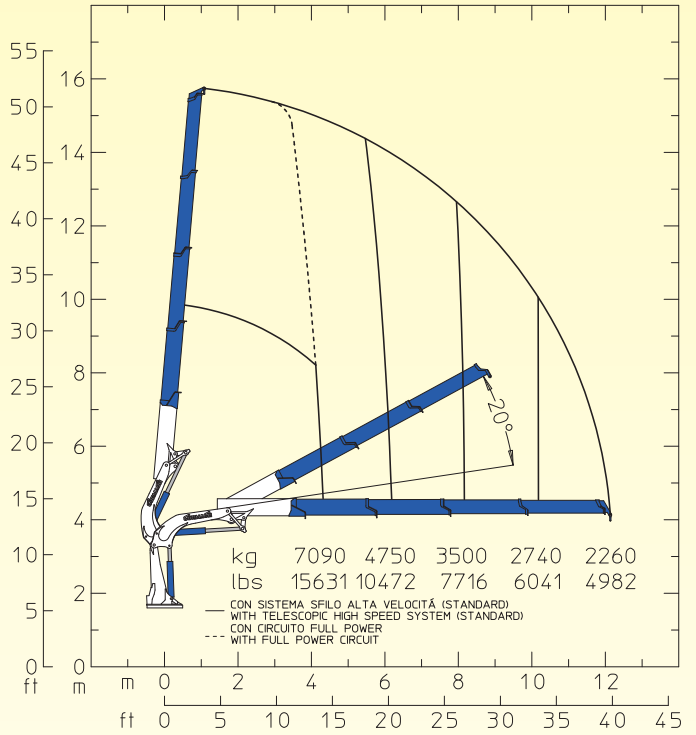

### STANDARD



### OPTIONAL

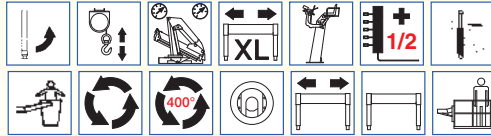

### STANDARD



### OPTIONAL

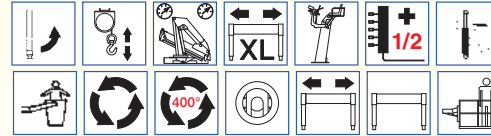

E3	E3		E4	E4
34500 da N*m	254460 Lb*ft	Momento statico massimo al perno torretta • Max. static moment at the turret pin Moment statique max. a l'axe de la tourelle • Max. statisches ubmoment am kran Saulenbolzen	34500 da N*m	254460 Lb*ft
10.04 m	33' 0" ft	Sbraccio idraulico • Hydraulic boom length Longueur du bras hydraulique • Hydraulic reichweite	12.14 m	39' 10" ft
/	/	Sbraccio con prolunghe manuali • Bomm length with manual extensions Longueur du bras avec rallonges manuelles	/	/
3700 da N*m	27290 Lb*ft	Coppia di rotazione • Slew torque • Moment de rotation • Drehmoment	3700 da N*m	27290 Lb*ft
sec. 33 - 360°	sec. 33 - 360°	Tempo di rotazione • Slewing speed • Temp de rotation • Schwenkgeschwindigkeit	sec. 33 - 360°	sec. 33 - 360°
1500+1750 mm	4' 11" + 5' 9" ft	Uscita stabilizzatori (*) • Outriggers extensions (*) Sortie des bequilles (*) • Breite der abstützung (*)	1500+1750 mm	4' 11" + 5' 9" ft
5630 mm	18' 6" ft	Larghezza stabilizzatori (***) • Outriggers width (***) Largeur des bequilles (***) • Breite der abstützung (***)	5630 mm	18' 6" ft
1220 mm	4' 0" ft	Lunghezza • Length • Longueur • Länge	1220 mm	4' 0" ft
2550 mm	8' 4" ft	Larghezza • Width • Largeur • Breite	2550 mm	8' 4" ft
2250 mm	7' 5" ft	Altezza • Height • Hauteur • Höhe	2250 mm	7' 5" ft
3650 Kg	8047 lbs	Peso (senza olio e montaggio) • Weight (without oil and fitting) Poids (sans huile et montage) • Gewicht (ohne öl und ohne)	3830 Kg	8444 lbs
60 l/min	16 us gal/min	Portata pompa (****) • Pump delivery (****) • Capacité de la pompe (****) • Pumpenheistung (****)	60 l/min	16 us gal/min
300 bar	4266 psi	Pressione • Pressure • Pression • Druck	300 bar	4266 psi
160 l	42 us gal	Capacità serbatoio olio • Oil tank capacity • Capacité de reservoir d'huile • Öl tank inhalt	160 l	42 us gal



## 34000 E5

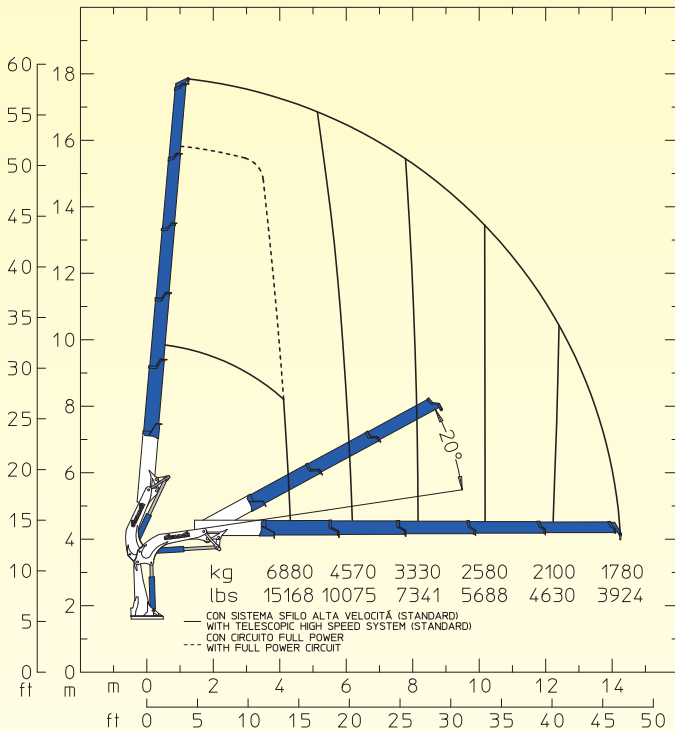

## 34000 E6

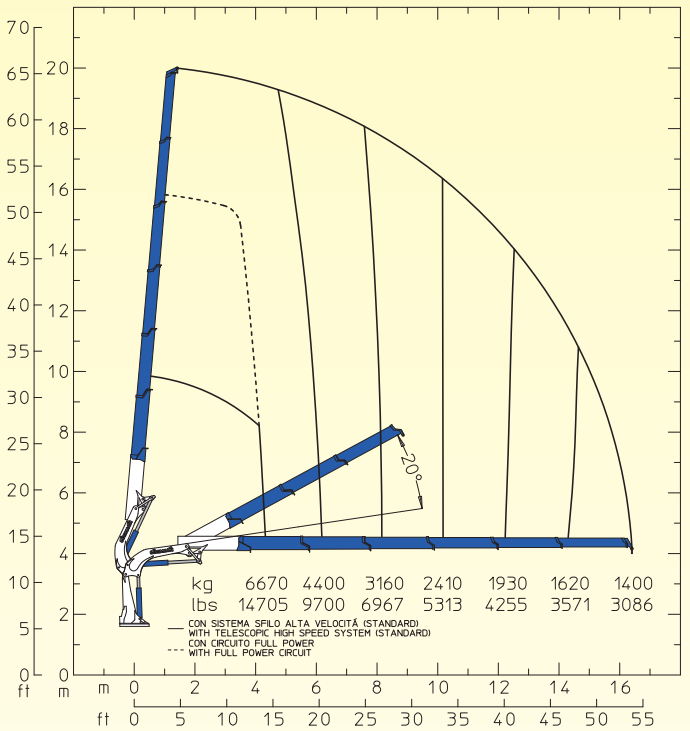

### STANDARD



### OPTIONAL

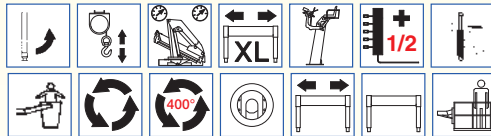

### STANDARD



### OPTIONAL

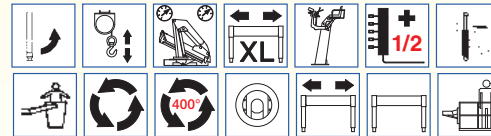

E5	E5		E6	E6
34500 da N*m	254460 Lb*ft	Momento statico massimo al perno torretta • Max. static moment at the turret pin Moment statique max. a l'axe de la tourelle • Max. statisches ubmmoment am kransaulenbolzen	34500 da N*m	254460 Lb*ft
14.25 m	46' 9" ft	Sbraccio idraulico • Hydraulic boom length Longueur du bras hydraulique • Hydraulic reichweite	16.40 m	53' 10" ft
/	/	Sbraccio con prolunghe manuali • Bomm length with manual extensions Longueur du bras avec rallonges manuelles	/	/
3700 da N*m	27290 Lb*ft	Coppia di rotazione • Slew torque • Moment de rotation • Drehmoment	3700 da N*m	27290 Lb*ft
sec. 33 - 360°	sec. 33 - 360°	Tempo di rotazione • Slewing speed • Temp de rotation • Schwenkgeschwindigkeit	sec. 33 - 360°	sec. 33 - 360°
1500+1750 mm	4' 11" + 5' 9" ft	Uscita stabilizzatori (*) • Outriggers extensions (*) Sortie des bequilles (*) • Breite der abstützung (*)	1500+1750 mm	4' 11" + 5' 9" ft
5630 mm	18' 6" ft	Larghezza stabilizzatori (***) • Outriggers width (***) Largeur des bequilles (***) • Breite der abstützung (***)	5630 mm	18' 6" ft
1220 mm	4' 0" ft	Lunghezza • Length • Longueur • Länge	1220 mm	4' 0" ft
2550 mm	8' 4" ft	Larghezza • Width • Largeur • Breite	2550 mm	8' 4" ft
2250 mm	7' 5" ft	Altezza • Height • Hauteur • Höhe	2250 mm	7' 5" ft
4000 Kg	8818 lbs	Peso (senza olio e montaggio) • Weight (without oil and fitting) Poids (sans huile et montage) • Gewicht (ohne öl und ohne)	4175 Kg	9204 lbs
60 l/min	16 us gal/min	Portata pompa (****) • Pump delivery (****) • Capacité de la pompe (****) • Pumpenheistung (****)	60 l/min	16 us gal/min
300 bar	4266 psi	Pressione • Pressure • Pression • Druck	300 bar	4266 psi
160 l	42 us gal	Capacità serbatoio olio • Oil tank capacity • Capacité de reservoir d'huile • Öl tank inhalt	160 l	42 us gal



# 34000 E A.S.C. PLUS EVO

## 34000 E7

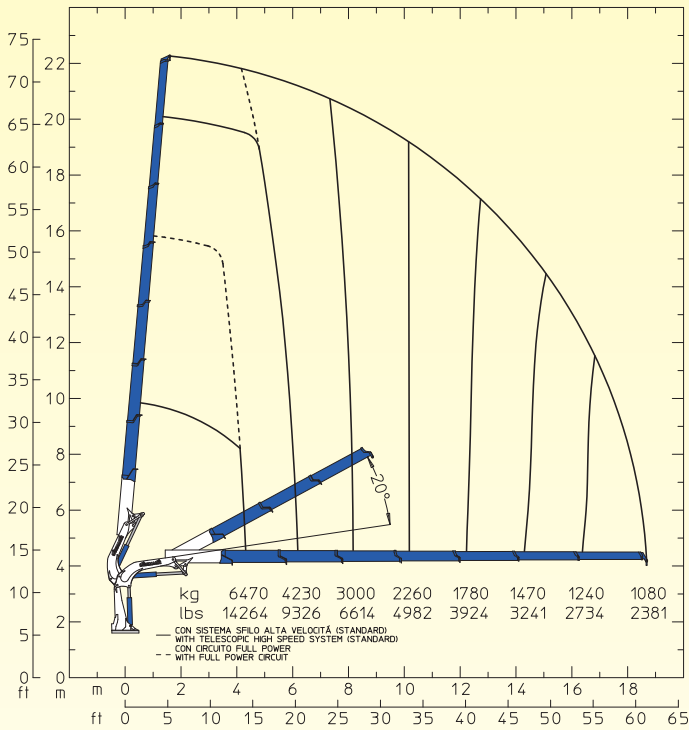

## 34000 E8

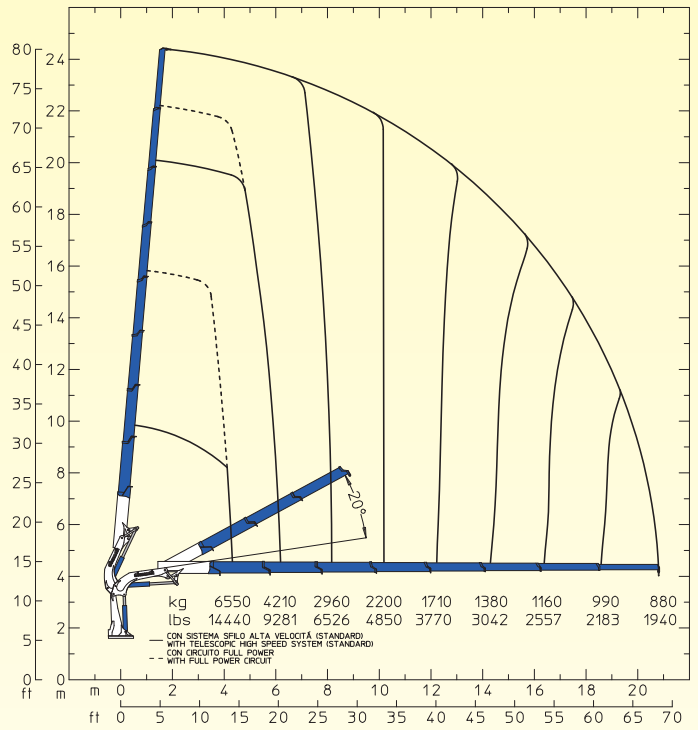

### STANDARD



### OPTIONAL

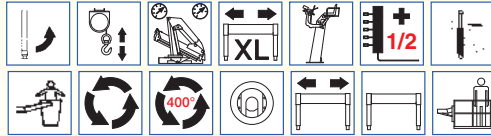

### STANDARD



### OPTIONAL

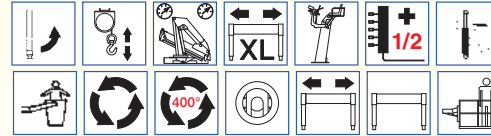

E7	E7		E8	E8
34500 da N*m	254460 Lb*ft	Momento statico massimo al perno torretta • Max. static moment at the turret pin Moment statique max. a l'axe de la tourelle • Max. statisches ubmoment am kran Saulenbolzen	34500 da N*m	254460 Lb*ft
18.68 m	61' 3" ft	Sbraccio idraulico • Hydraulic boom length Longueur du bras hydraulique • Hydraulic reichweite	20.81 m	68' 3" ft
/	/	Sbraccio con prolunghe manuali • Boom length with manual extensions Longueur du bras avec rallonges manuelles	/	/
3700 da N*m	27290 Lb*ft	Coppia di rotazione • Slew torque • Moment de rotation • Drehmoment	3700 da N*m	27290 Lb*ft
sec. 33 - 360°	sec. 33 - 360°	Tempo di rotazione • Slewing speed • Temp de rotation • Schwenkgeschwindigkeit	sec. 33 - 360°	sec. 33 - 360°
1500+1750 mm	4' 11" + 5' 9" ft	Uscita stabilizzatori (*) • Outriggers extensions (*) Sortie des bequilles (*) • Breite der abstützung (*)	1500+1750 mm	4' 11" + 5' 9" ft
5630 mm	18' 6" ft	Larghezza stabilizzatori (***) • Outriggers width (***) Largeur des bequilles (***) • Breite der abstützung (***)	5630 mm	18' 6" ft
1220 mm	4' 0" ft	Lunghezza • Length • Longueur • Länge	1220 mm	4' 0" ft
2550 mm	8' 4" ft	Larghezza • Width • Largeur • Breite	2550 mm	8' 4" ft
2250 mm	7' 5" ft	Altezza • Height • Hauteur • Höhe	2250 mm	7' 5" ft
4330 Kg	9546 lbs	Peso (senza olio e montaggio) • Weight (without oil and fitting) Poids (sans huile et montage) • Gewicht (ohne öl und ohne)	4435 Kg	9777 lbs
60 l/min	16 us gal/min	Portata pompa (****) • Pump delivery (****) • Capacité de la pompe (****) • Pumpenleistung (****)	60 l/min	16 us gal/min
300 bar	4266 psi	Pressione • Pressure • Pression • Druck	300 bar	4266 psi
160 l	42 us gal	Capacità serbatoio olio • Oil tank capacity • Capacité de reservoir d'huile • Öl tank inhalt	160 l	42 us gal



## 34000 E5F62

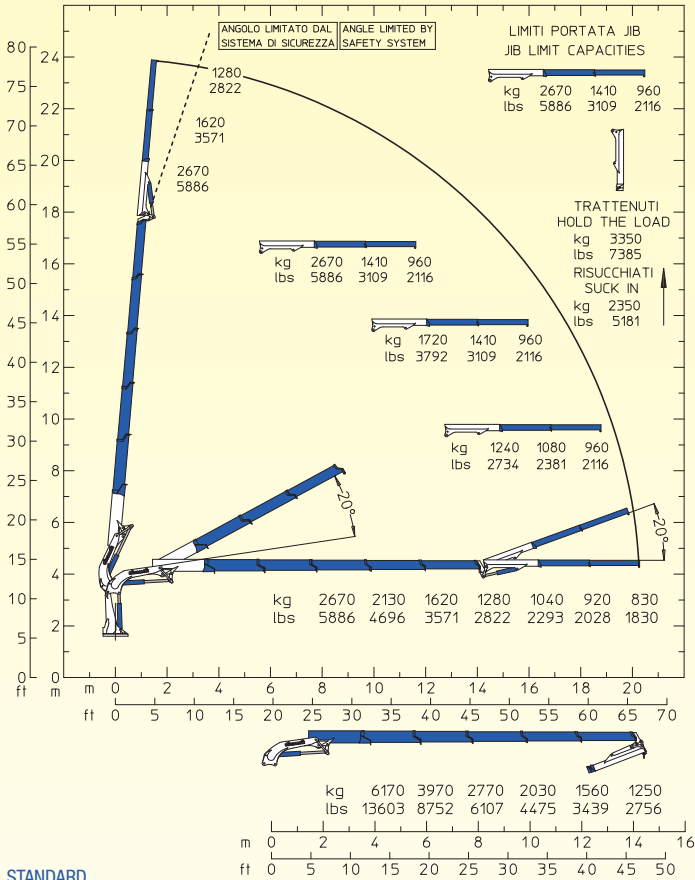

**STANDARD**



**OPTIONAL**

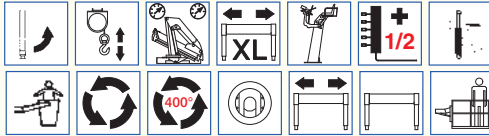

## 34000 E5F63

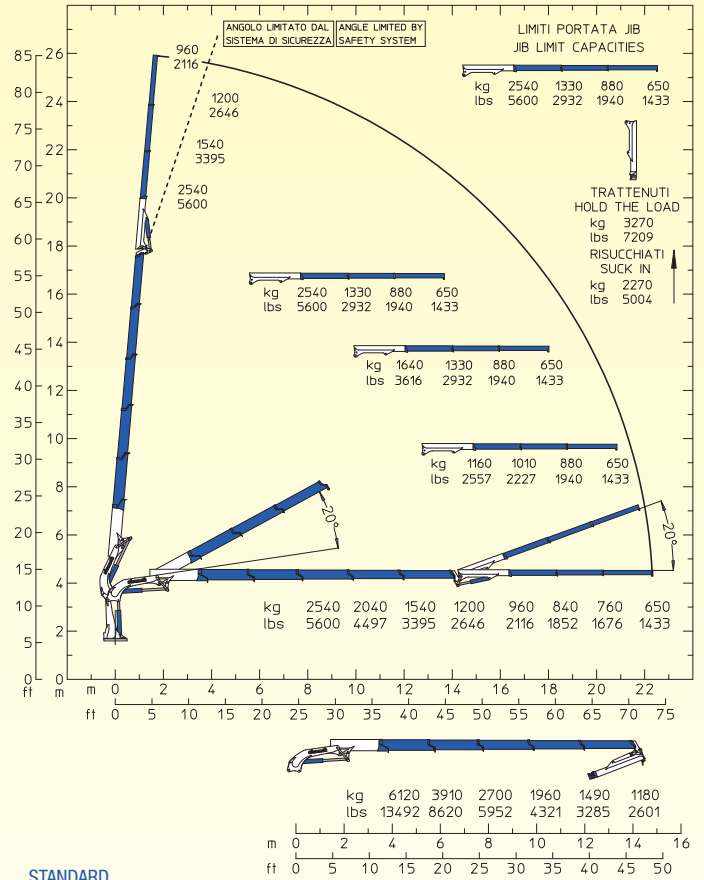

**STANDARD**



**OPTIONAL**

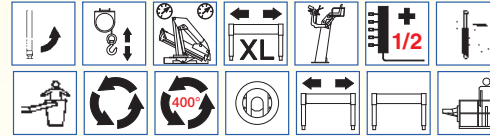

E5F62	E5F62		E5F63	E5F63
34500 da N*m	254460 Lb*ft	Momento statico massimo al perno torretta • Max. static moment at the turret pin Moment statique max. a l'axe de la tourelle • Max. statisches ubmoment am kransaulenbolzen	34500 da N*m	254460 Lb*ft
20.30 m	66' 7" ft	Sbraccio idraulico • Hydraulic boom length Longueur du bras hydraulique • Hydraulic reichweite	22.35 m	73' 4" ft
/	/	Sbraccio con prolunghe manuali • Bomm length with manual extensions Longueur du bras avec rallonges manuelles	/	/
3700 da N*m	27290 Lb*ft	Coppia di rotazione • Slew torque • Moment de rotation • Drehmoment	3700 da N*m	27290 Lb*ft
sec. 33 - 360°	sec. 33 - 360°	Tempo di rotazione • Slewing speed • Temp de rotation • Schwenkgeschwindigkeit	sec. 33 - 360°	sec. 33 - 360°
1500+1750 mm	4' 11" + 5' 9" ft	Uscita stabilizzatori (*) • Outriggers extensions (*) Sortie des bequilles (*) • Breite der abstützung (*)	1500+1750 mm	4' 11" + 5' 9" ft
5630 mm	18' 6" ft	Larghezza stabilizzatori (***) • Outriggers width (***) Largeur des bequilles (***) • Breite der abstützung (***)	5630 mm	18' 6" ft
1220 mm	4' 0" ft	Lunghezza • Length • Longueur • Länge	1220 mm	4' 0" ft
2550 mm	8' 4" ft	Larghezza • Width • Largeur • Breite	2550 mm	8' 4" ft
2510 mm	8' 3" ft	Altezza • Height • Hauteur • Höhe	2510 mm	8' 3" ft
4610 Kg	10163 lbs	Peso (senza olio e montaggio) • Weight (without oil and fitting) Poids (sans huile et montage) • Gewicht (ohne öl und ohne)	4690 Kg	10340 lbs
60 l/min	16 us gal/min	Portata pompa (****) • Pump delivery (****) • Capacité de la pompe (****) • Pumpenheistung (****)	60 l/min	16 us gal/min
300 bar	4266 psi	Pressione • Pressure • Pression • Druck	300 bar	4266 psi
160 l	42 us gal	Capacità serbatoio olio • Oil tank capacity • Capacité de reservoir d'huile • Öl tank inhalt	160 l	42 us gal



# 34000 E A.S.C. PLUS EVO

## 34000 E5F64

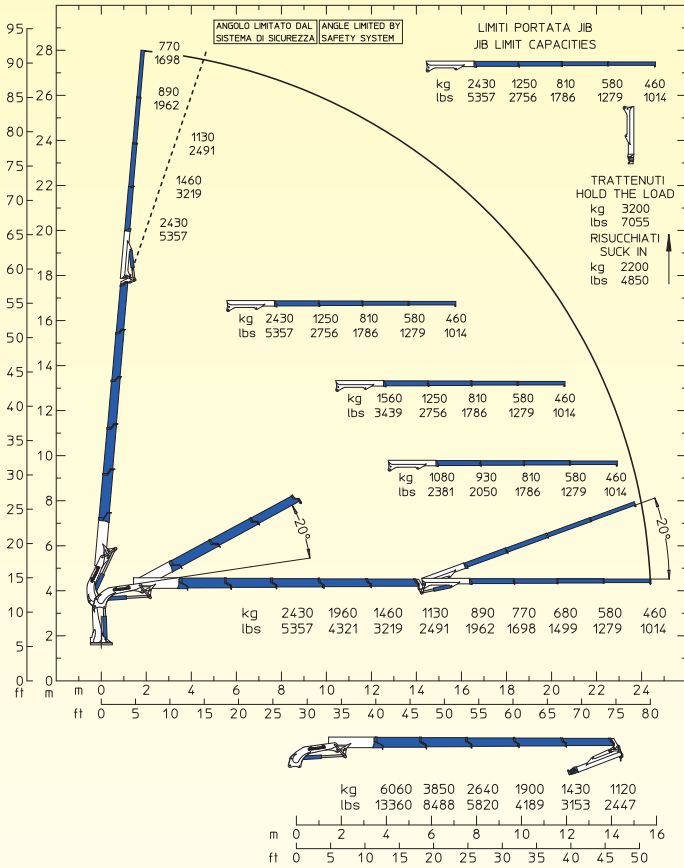

## 34000 E6F62

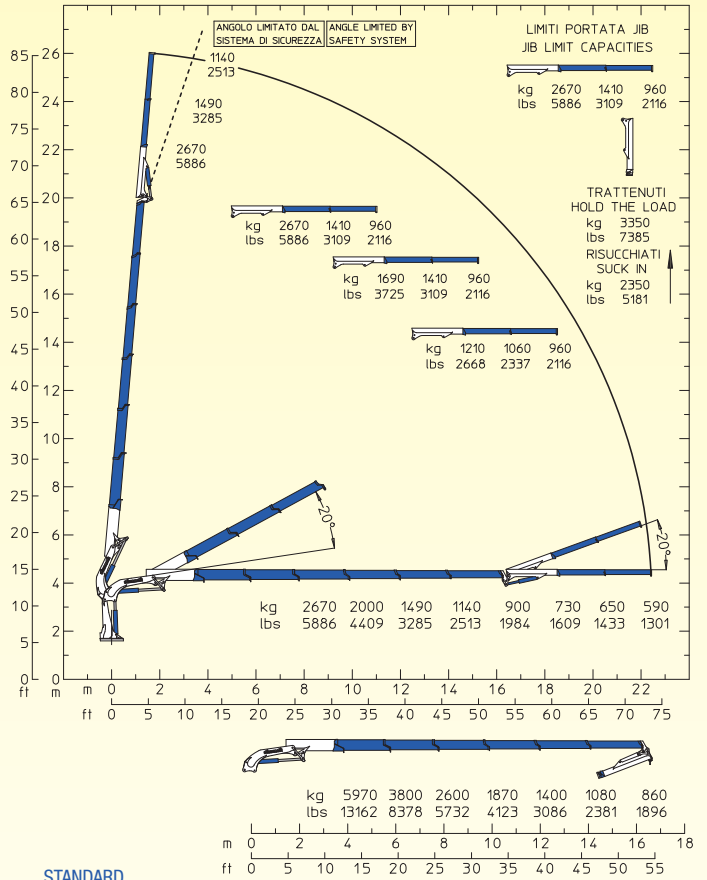

### STANDARD



### OPTIONAL

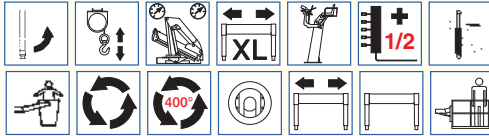

### STANDARD



### OPTIONAL

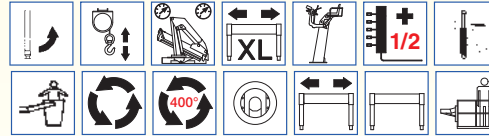

E5F64	E5F64		E6F62	E6F62
34500 da N*m	254460 Lb*ft	Momento statico massimo al perno torretta • Max. static moment at the turret pin Moment statique max. a l'axe de la tourelle • Max. statisches ubmoment am kran Saulenbolzen	34500 da N*m	254460 Lb*ft
24.40 m	80' 1" ft	Sbraccio idraulico • Hydraulic boom length Longueur du bras hydraulique • Hydraulic reichweite	22.45 m	73' 8" ft
/	/	Sbraccio con prolunghe manuali • Bomm length with manual extensions Longueur du bras avec rallonges manuelles	/	/
3700 da N*m	27290 Lb*ft	Coppia di rotazione • Slew torque • Moment de rotation • Drehmoment	3700 da N*m	27290 Lb*ft
sec. 33 - 360°	sec. 33 - 360°	Tempo di rotazione • Slewing speed • Temp de rotation • Schwenkgeschwindigkeit	sec. 33 - 360°	sec. 33 - 360°
1500+1750 mm	4' 11" + 5' 9" ft	Uscita stabilizzatori (*) • Outriggers extensions (*) Sortie des bequilles (*) • Breite der abstützung (*)	1500+1750 mm	4' 11" + 5' 9" ft
5630 mm	18' 6" ft	Larghezza stabilizzatori (***) • Outriggers width (***) Largeur des bequilles (***) • Breite der abstützung (***)	5630 mm	18' 6" ft
1220 mm	4' 0" ft	Lunghezza • Length • Longueur • Länge	1220 mm	4' 0" ft
2550 mm	8' 4" ft	Larghezza • Width • Largeur • Breite	2550 mm	8' 4" ft
2510 mm	8' 3" ft	Altezza • Height • Hauteur • Höhe	2510 mm	8' 3" ft
4770 Kg	10516 lbs	Peso (senza olio e montaggio) • Weight (without oil and fitting) Poids (sans huile et montage) • Gewicht (ohne öl und ohne)	4780 Kg	10538 lbs
60 l/min	16 us gal/min	Portata pompa (****) • Pump delivery (****) • Capacité de la pompe (****) • Pumpenheistung (****)	60 l/min	16 us gal/min
300 bar	4266 psi	Pressione • Pressure • Pression • Druck	300 bar	4266 psi
160 l	42 us gal	Capacità serbatoio olio • Oil tank capacity • Capacité de reservoir d'huile • Öl tank inhalt	160 l	42 us gal

Opzione • Option • Option • Option: (\*) 2100 + 2350 (6' 11" + 7' 9") - (\*\*) 6830 (22' 5") - (\*\*\*) Consigliata / Recommended / Reconnmé / Empfohlen.



## 34000 E6F63

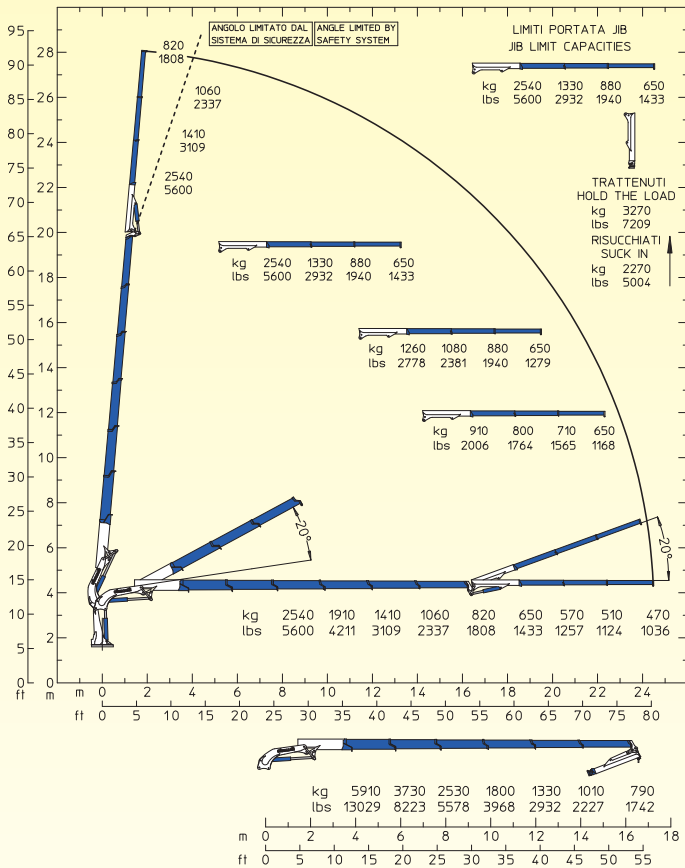

## 34000 E6F64

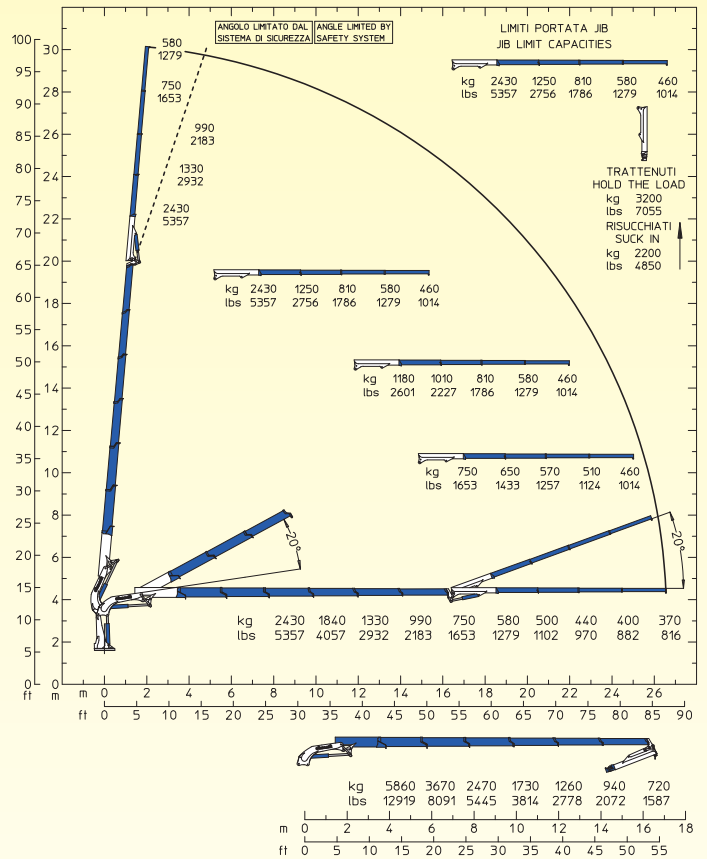

### STANDARD



### OPTIONAL

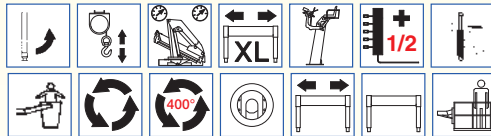

### STANDARD



### OPTIONAL

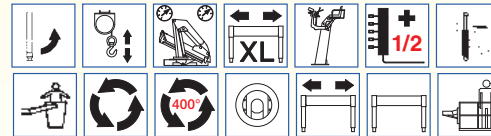

E6F63	E6F63		E6F64	E6F64
34500 da N*m	254460 Lb*ft	Momento statico massimo al perno torretta • Max. static moment at the turret pin Moment statique max. a l'axe de la tourelle • Max. statisches ubmoment am Kransaulenbolzen	34500 da N*m	254460 Lb*ft
24.50 m	80' 5" ft	Sbraccio idraulico • Hydraulic boom length Longueur du bras hydraulique • Hydraulic reichweite	26.55 m	87' 1" ft
/	/	Sbraccio con prolunghe manuali • Bomm length with manual extensions Longueur du bras avec rallonges manuelles	/	/
3700 da N*m	27290 Lb*ft	Coppia di rotazione • Slew torque • Moment de rotation • Drehmoment	3700 da N*m	27290 Lb*ft
sec. 33 - 360°	sec. 33 - 360°	Tempo di rotazione • Slewing speed • Temp de rotation • Schwenkgeschwindigkeit	sec. 33 - 360°	sec. 33 - 360°
1500+1750 mm	4' 11" + 5' 9" ft	Uscita stabilizzatori (*) • Outriggers extensions (*) Sortie des bequilles (*) • Breite der abstützung (*)	1500+1750 mm	4' 11" + 5' 9" ft
5630 mm	18' 6" ft	Larghezza stabilizzatori (***) • Outriggers width (***) Largeur des bequilles (***) • Breite der abstützung (***)	5630 mm	18' 6" ft
1220 mm	4' 0" ft	Lunghezza • Length • Longueur • Länge	1220 mm	4' 0" ft
2550 mm	8' 4" ft	Larghezza • Width • Largeur • Breite	2550 mm	8' 4" ft
2510 mm	8' 3" ft	Altezza • Height • Hauteur • Höhe	2510 mm	8' 3" ft
4860 Kg	10714 lbs	Peso (senza olio e montaggio) • Weight (without oil and fitting) Poids (sans huile et montage) • Gewicht (ohne öl und ohne)	4940 Kg	10891 lbs
60 l/min	16 us gal/min	Portata pompa (****) • Pump delivery (****) • Capacité de la pompe (****) • Pumpenheistung (****)	60 l/min	16 us gal/min
300 bar	4266 psi	Pressione • Pressure • Pression • Druck	300 bar	4266 psi
160 l	42 us gal	Capacità serbatoio olio • Oil tank capacity • Capacité de reservoir d'huile • Öl tank inhalt	160 l	42 us gal



# 34000 E A.S.C. PLUS **EVO**

E3		E4		E5		E6		E7		E8	
m/ft	kg/lbs	m/ft	kg/lbs	m/ft	kg/lbs	m/ft	kg/lbs	m/ft	kg/lbs	m/ft	kg/lbs
4.18	7320	4.24	7090	4.30	6880	4.36	6670	4.42	6470	4.32	6550
13'9"	16138	13'11"	15631	14'2"	15168	14'4"	14705	14'6"	14264	14'2"	14440
6.07	4940	6.13	4750	6.19	4570	6.25	4400	6.31	4230	6.21	4210
19'11"	10891	20'1"	10472	20'4"	10075	20'6"	9700	20'8"	9326	20'4"	9281
8.02	3680	8.08	3500	8.14	3330	8.20	3160	8.26	3000	8.16	2960
26'4"	8113	26'6"	7716	26'9"	7341	26'11"	6967	27'1"	6614	26'9"	6526
10.04	2910	10.10	2740	10.16	2580	10.22	2410	10.28	2260	10.18	2200
33'0"	6415	33'2"	6041	33'4"	5688	33'6"	5313	33'9"	4982	33'5"	4850
		12.14	2260	12.20	2100	12.26	1930	12.32	1780	12.22	1710
		39'10"	4982	40'1"	4630	40'3"	4255	40'5"	3924	40'1"	3770
				14.25	1780	14.31	1620	14.37	1470	14.27	1380
				46'9"	3924	46'11"	3571	47'2"	3241	46'10"	3042
						16.40	1400	16.46	1240	16.37	1160
						53'10"	3086	54'0"	2734	53'8"	2557
								18.68	1080	18.58	990
								61'3"	2381	60'11"	2183
										20.81	880
										68'3"	1940

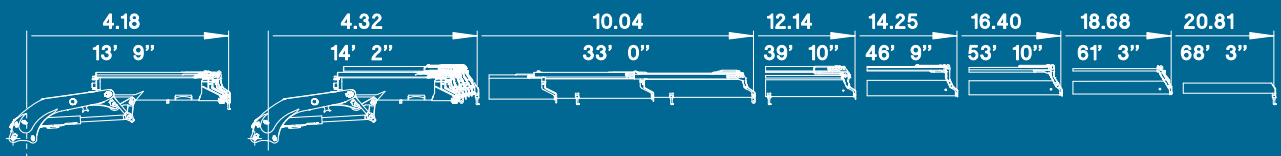

**E8**

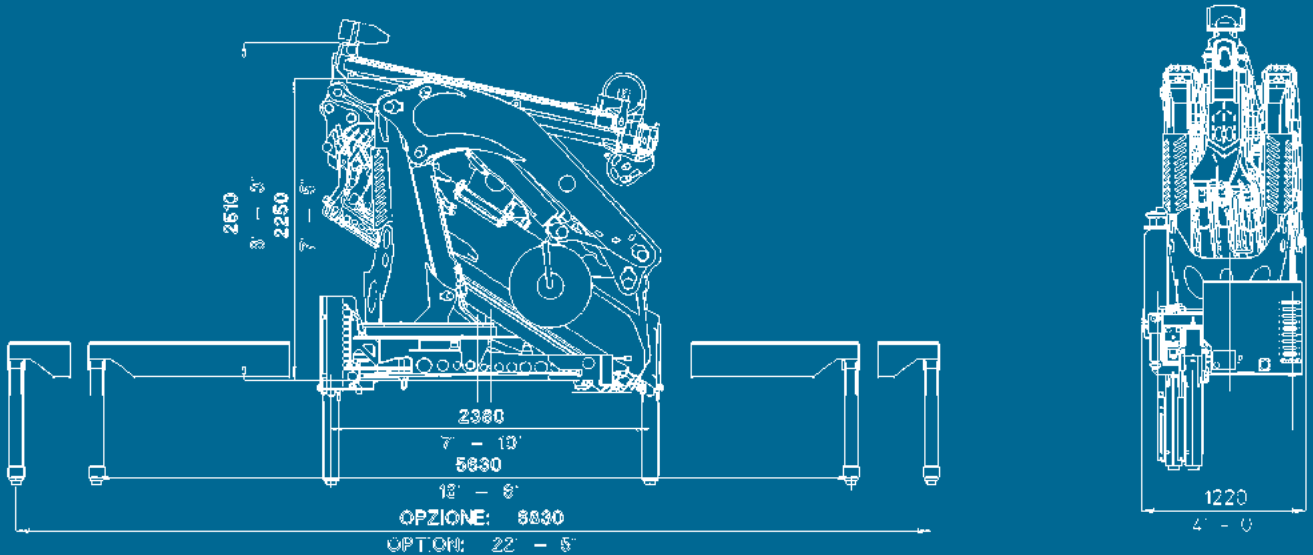



E5F62		E5F63		E5F64		E6F62		E6F63		E6F64	
m/ft	kg/lbs	m/ft	kg/lbs	m/ft	kg/lbs	m/ft	kg/lbs	m/ft	kg/lbs	m/ft	kg/lbs
8.57	2670	8.64	2540	8.71	2430	8.63	2670	8.70	2540	8.76	2430
28'1"	5886	28'4"	5600	28'7"	5357	28'4"	5886	28'7"	5600	28'9"	5357
10.52	2130	10.59	2040	10.66	1960	10.58	2000	10.65	1910	10.71	1840
34'6"	4696	34'9"	4497	35'0"	4321	34'9"	4409	35'0"	4211	35'2"	4057
12.54	1620	12.61	1540	12.68	1460	12.60	1490	12.67	1410	12.73	1330
41'1"	3571	41'4"	3395	41'7"	3219	41'4"	3285	41'7"	3109	41'9"	2932
14.58	1280	14.65	1200	14.72	1130	14.64	1140	14.71	1060	14.77	990
47'9"	2822	48'0"	2646	48'3"	2491	48'0"	2513	48'3"	2337	48'5"	2183
16.63	1040	16.70	960	16.77	890	16.69	900	16.76	820	16.82	750
54'6"	2293	54'9"	2116	55'0"	1962	54'9"	1984	55'0"	1808	55'2"	1653
18.46	920	18.53	840	18.60	770	18.78	730	18.85	650	18.92	580
60'6"	2028	60'9"	1852	61'0"	1698	61'7"	1609	61'10"	1433	62'1"	1279
20.30	830	20.37	760	20.44	680	20.61	650	20.68	570	20.75	500
66'7"	1830	66'10"	1676	67'1"	1499	67'7"	1433	67'10"	1257	68'1"	1102
		22.35	650	22.42	580	22.45	590	22.52	510	22.59	440
		73'4"	1433	73'7"	1279	73'8"	1301	73'11"	1124	74'1"	970
				24.40	460			24.50	470	24.57	400
				80'1"	1014			80'5"	1036	80'7"	882
										26.55	370
										87'1"	816

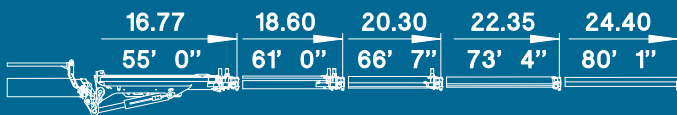

**E5F64**

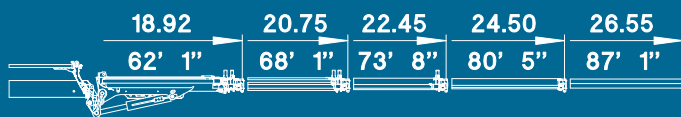

**E6F64**

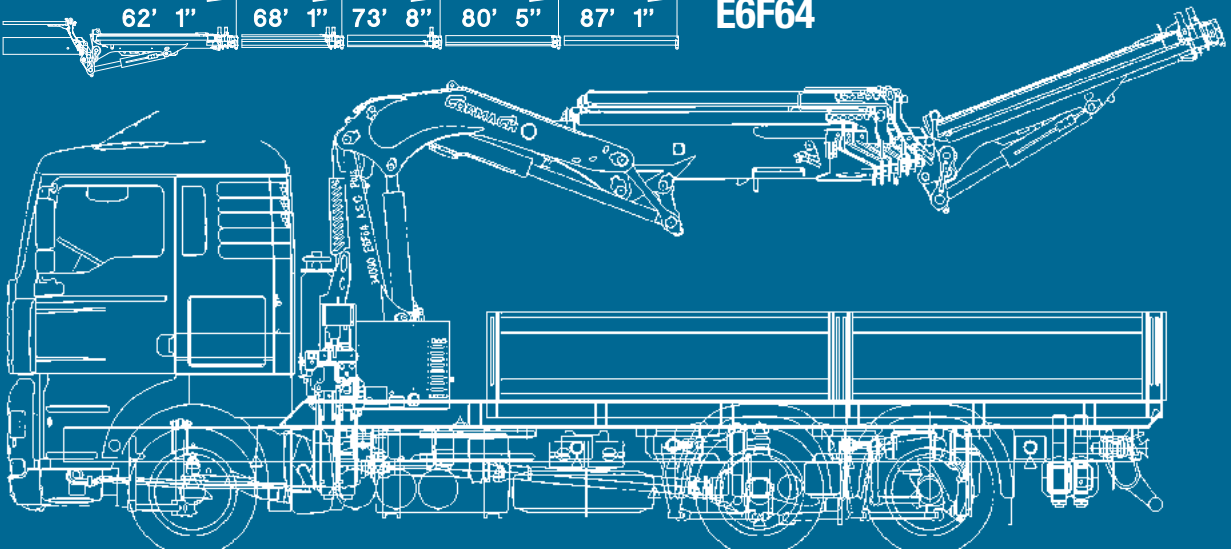



# 34000 E A.S.C. PLUS EVO

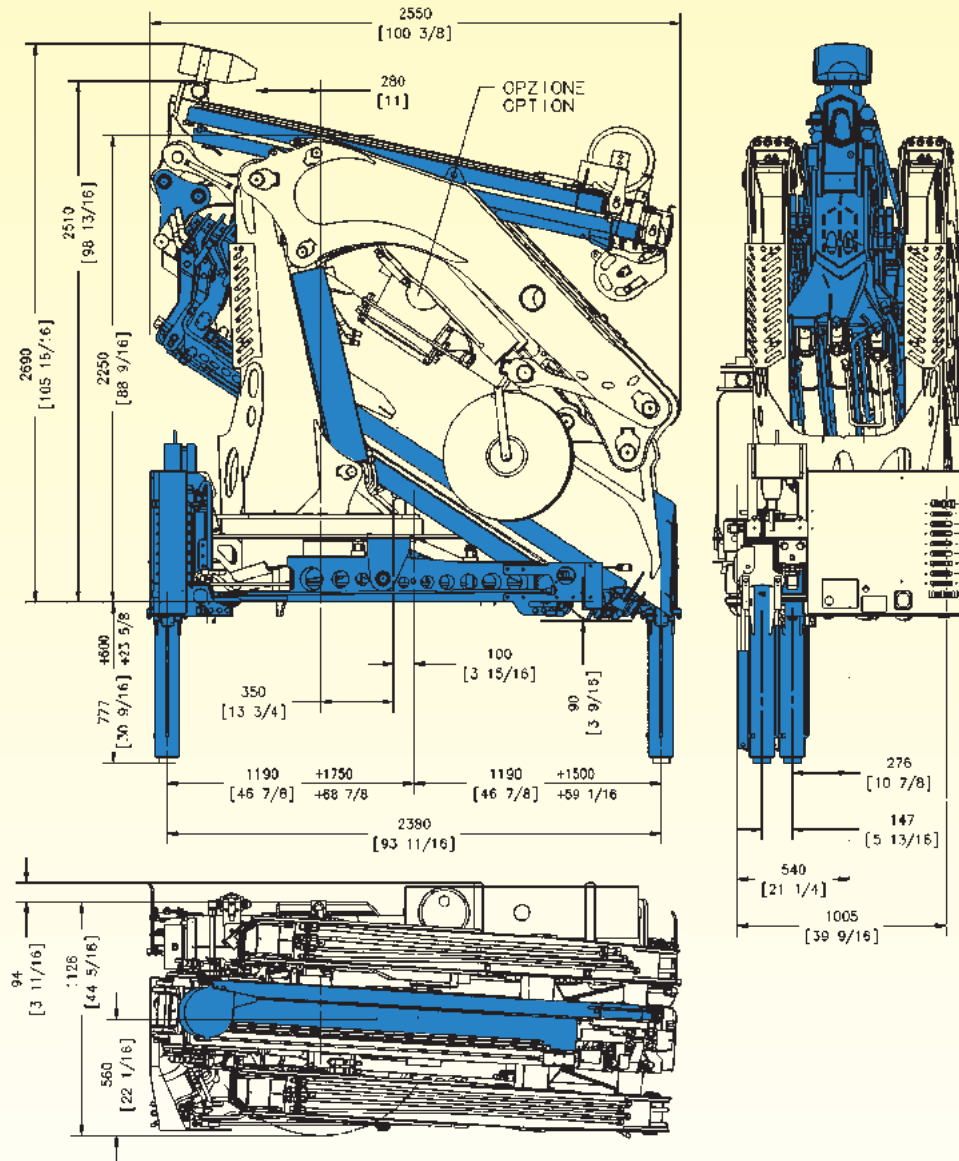

## STANDARD



Rotazione 360°  
Rotation 360°  
Rotation 360°  
Drehbereich 360°



Radiocomando  
Radio remote control  
Radiocommandes  
Funkfernsteuerung



Comando supplementare non attivato (1)  
Additional free section not activated (1)  
Section du distributeur pas activé (1)  
Zusätzlicher steuerschieber (1)



Limitatore di momento  
Load limiting device  
Limiteur de charge  
Überlastabschal tungssystem



Stabilizzatori gru base estendibili idraulicamente  
Outriggers with hydraulic  
Stabilisateurs avec extension hydraulique  
Hydraulisch ausfahrbare stützen



Automatic Speed Control  
Automatic Speed Control  
Automatic Speed Control  
Automatic Speed Control



Scambiatore di calore  
Oil cooler  
Echangeur de chaleur  
Ölkühler

## OPTIONAL



Stabilizzatori gru base girevoli  
Tilt up outriggers  
Bequilles tournants  
Drehbare stützen



Verricello  
Winch  
Treuil  
Sellwinde



Doppio limitatore di momento  
Double load limiting device  
Double limiteur de charge  
Doppel Überlastabschal tungssystem



Stabilizzatori gru base extralarghi  
Extra wide crane outriggers  
Stabilisateurs grue extra large  
Extra breite kran stützen



Posto di manovra in alto  
Top seat  
Siege en haut  
Hochsitz



Comando supplementare attivato (1/2)  
Additional function (1/2)  
Section du distributeur activée (1/2)  
Zusatzfunktion (1/2)



Trattamento marino della gru  
Marine treatment of the crane  
Traitement marine de la grue  
Marine behandlung des kranes



Cestello  
Basket  
Nacelle  
Personenkorb



Rotazione continua  
Continuos rotation  
Rotation continue  
Endlos schwenkwerk



Rotazione 400°  
Rotation 400°  
Rotation 400°  
Drehbereich 400°



Piastre di appoggio maggiorate  
Large ground plates  
Plaques stabilisateurs  
Bodenplatten



Traversa ausiliaria estendibile  
Additional outriggers with lateral extension  
Stabilisateur supplementaires avec elargissement  
Ausfahrbare zusatz- stützen



Traversa ausiliaria fissa  
Additional outriggers beam without extension  
Stabilisateur supplementaires sans elargissement  
Zusätzliche abstützbeine



Piattaforma autolivellante  
Self leveling platform  
Plateforme auto nivelante  
Arbeitskorb mit automatische Ausgleich Analage







# 34000 E A.S.C. PLUS **EVO**











# CORMAGH

Cormach s.r.l. - Via Madonna, 27 - C.P. 199 - 25018 MONTICHIARI (BS) - ITALY  
Tel. 0039.030.9656811 - Telefax 0039.030.9656846.7.8  
E-mail: [info@cormach.com](mailto:info@cormach.com) - [www.cormach.com](http://www.cormach.com)

A fronte di una continua ricerca tecnologica i dati possono cambiare senza preavviso. Contattare il nostro Ufficio Commerciale per ulteriori informazioni.  
Because of continuous technology research data can change without notice. Please, contact our Commercial Dept. for further information.  
A cause de une continue recherche technologique les données peuvent changer sans préavis. Contacter notre Bureau Commercial pour des autres informations.  
Irrtum und technische Änderung vorbehalten. Masse und Gewichte unverbindlich. Unser Vertrieb erteilt Ihnen gerne weitere Auskünfte. Bitte rufen Sie uns an.  
Debito a los continuos avances tecnológicos los datos pueden variar sin notificación previa. Para más información rogamos contacten nuestro Departamento Comercial.